

ENCHANT 1300  
ENCHANT 800  
ENCHANT SUBWOOFER

/



OWNER'S  
MANUAL

# / IMPORTANT SAFETY INSTRUCTIONS

## **Verify Line Voltage Before Use**

The Enchant soundbars have been designed for use with 100-240 volt, 50/60 Hz AC current. Connection to a line voltage other than that for which your product is intended can create a safety and fire hazard and may damage the unit. If you have any questions about the voltage requirements for your specific model or about the line voltage in your area, contact your selling dealer before plugging the unit in to a wall outlet.

## **Do Not Use Extension Cords**

To avoid safety hazards, use only the power cord supplied with your unit. We do not recommend that extension cords be used with this product. As with all electrical devices, do not run power cords under rugs or carpets, or place heavy objects on them. Damaged power cords should be replaced immediately by an authorized service center with a cord that meets factory specifications.

## **Handle the AC Power Cord Gently**

When disconnecting the power cord from an AC outlet, always pull the plug; never pull the cord. If you do not intend to use your speaker for any considerable length of time, disconnect the plug from the AC outlet.

## **Do Not Open the Cabinet**

There are no user-serviceable components inside this product. Opening the cabinet may present a shock hazard, and any modification to the product will void your warranty. If water accidentally falls inside the unit, disconnect it from the AC power source immediately, and consult an authorized service center.

# / TABLE OF CONTENTS

IMPORTANT SAFETY INSTRUCTIONS.....	2
INTRODUCTION .....	4
WHAT'S IN THE BOX.....	5
PRODUCT OVERVIEW.....	7
INSTALLATION.....	15
CONNECTING TO YOUR TV.....	19
CONNECTING TO OTHER DEVICES .....	21
CONNECTING TO POWER .....	23
CONNECTING TO WI-FI.....	27
USING YOUR SOUNDBAR.....	28
SETTINGS.....	32
UPDATE SOFTWARE .....	35
SPECIFICATIONS.....	36
TROUBLESHOOTING.....	40
OPEN SOURCE LICENSE NOTICE .....	42
LICENSE.....	43

# / INTRODUCTION

This manual includes information of the Enchant 1300, Enchant 800 and Enchant Subwoofer. We encourage you to take a few minutes to read this manual, which describes the products and includes step-by-step instructions to help you set up and get started. Read and understand all the safety instructions before using your product.

**This product may have an important software update available. Please follow the instructions to connect the product to Wi-Fi to ensure that your product has the most recent software updates.**

Design and specifications are subject to change without notice.

If you have any questions about these products, their installation or their operation, please contact your Harman Kardon retailer or customer service, or visit us at [www.harmankardon.com](http://www.harmankardon.com)

# / WHAT'S IN THE BOX

Carefully unpack the box and check if the following parts are included. If any part is damaged, do not use it, contact your Harman Kardon retailer or customer service.

## ENCHANT 1300 / ENCHANT 800

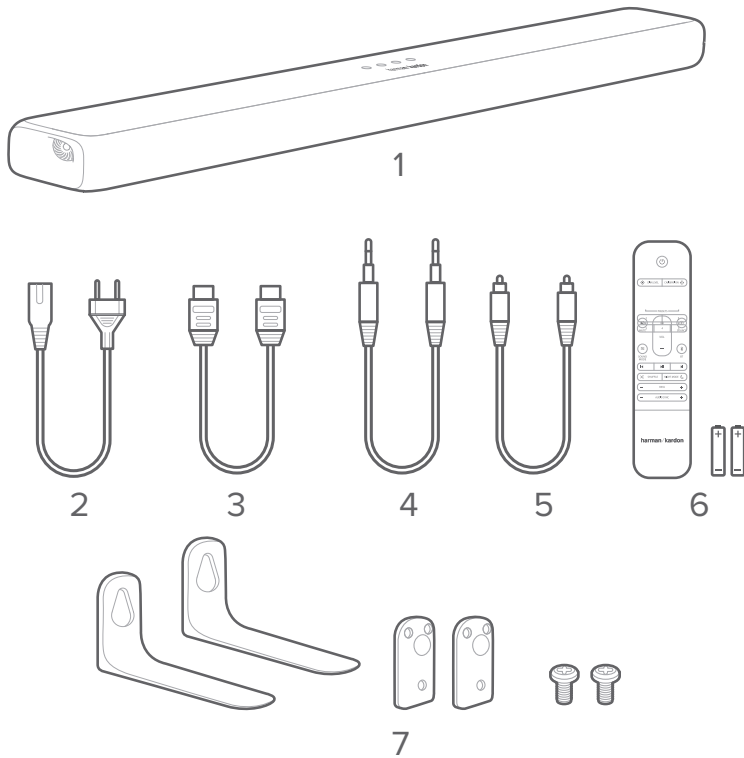

1. Main unit
2. Power cord\*
3. HDMI cable
4. AUX cable
5. Optical cable
6. Remote control (with 2 AAA batteries)
7. Wall-mount brackets

\* Power cord quantity and plug type vary by regions.

## Inserting Batteries before using the Remote Control (AAA batteries X 2)

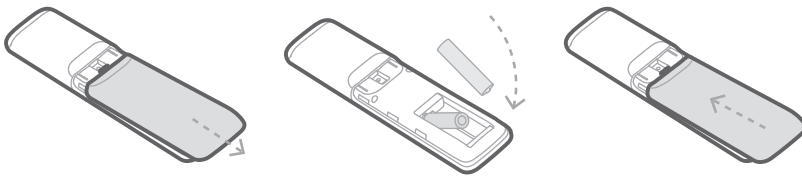

Slide the battery cover in the direction of the arrow until it is completely removed. Insert 2 AAA batteries (1.5V) oriented so that their polarity is correct. Slide the battery cover back into position.

## ENCHANT SUBWOOFER (Optional)

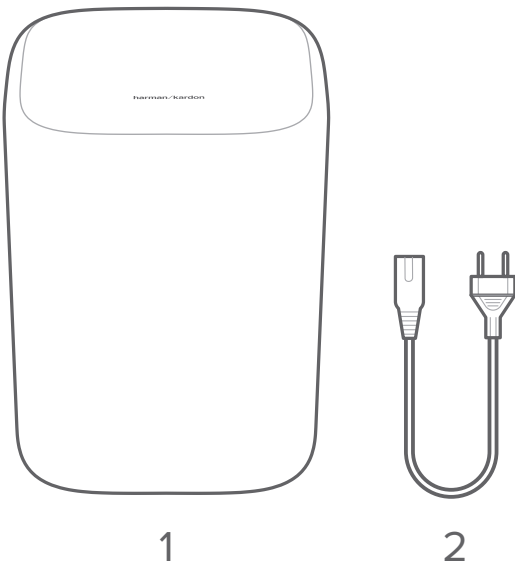

1. Main unit
2. Power cord\*

\* Power cord quantity and plug type vary by regions.

# PRODUCT OVERVIEW

## Front Panel & Top Panel of the Soundbar

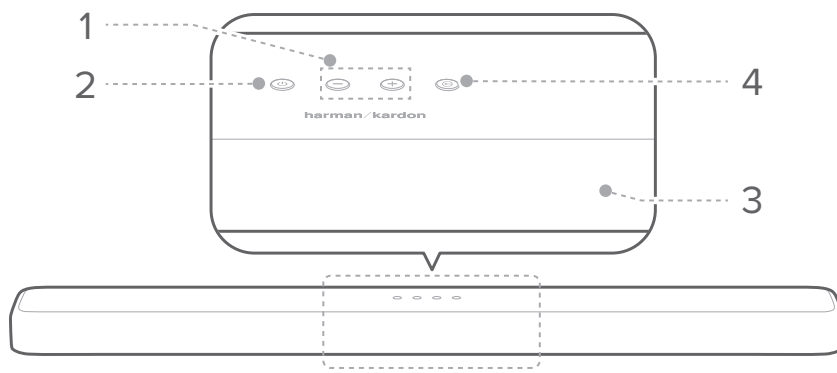

### 1. + / - (Volume)

- Adjust the volume level.
- Press both simultaneously to mute the soundbar.

### 2. ⏻ (Power)

- Turn the power on or to standby.
- Press and hold for 5 seconds to reset the soundbar Wi-Fi settings.

### 3. Display panel

- Display the current mode and status.

#### 4. (Source)

- Select the source input mode:

Source Input Mode	Display
HDMI OUT (TV ARC)	TV ARC
HDMI 1 input	HDMI 1
HDMI 2 input*	HDMI 2
HDMI 3 input*	HDMI 3
Optical input	OPT
Aux input	AUX
Bluetooth input	BT
USB input	USB

\* HDMI 2 and HDMI 3 are available on the Enchant 1300 only.



## Back Panel of the Soundbar

### ENCHANT 1300

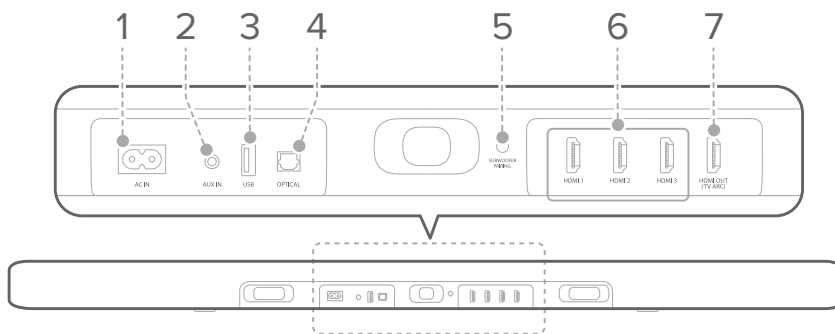

### ENCHANT 1300

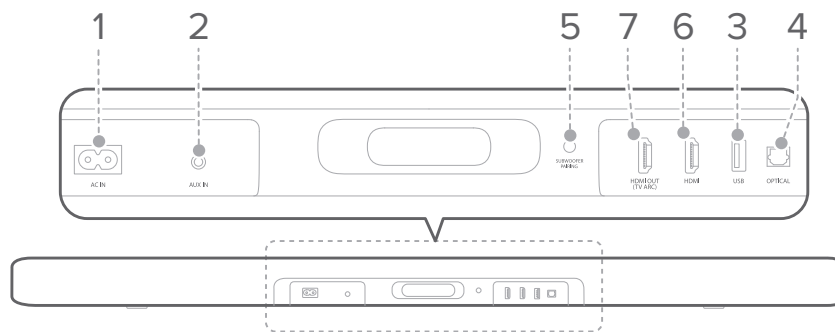

#### 1. AC IN

- Connect to the power cord, then connect the power cord to a wall outlet.

#### 2. AUX IN

- Connect to the Analog output of an external audio device.

#### 3. USB

- Connect to a USB storage device to play music.

#### 4. OPTICAL

- Connect to the optical audio output on your TV or digital device.

#### 5. SUBWOOFER PAIRING

- Press to enter the subwoofer pairing mode.
- Press and hold to disconnect and re-enter the subwoofer pairing mode.

#### 6. HDMI 1 / HDMI 2\* / HDMI 3\*

- Input digital video and audio signals simultaneously using an HDMI cable.
- Connect to the HDMI output on a digital device.

#### 7. HDMI OUT (TV ARC)

- Connect to the **HDMI (ARC)** input on your TV.

\* HDMI 2 and HDMI 3 are available on the Enchant 1300 only.

## Back Panel of the Subwoofer

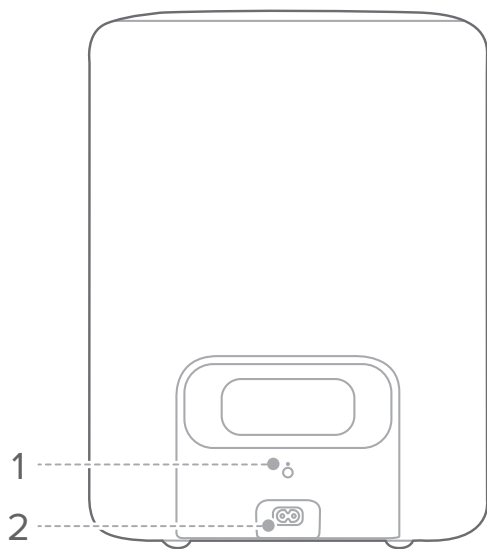

### 1. PAIRING

- Press to pair the subwoofer with the Enchant soundbar.

### 2. AC IN

- Connect to the power cord, then connect the power cord to a wall outlet.

## Remote Control

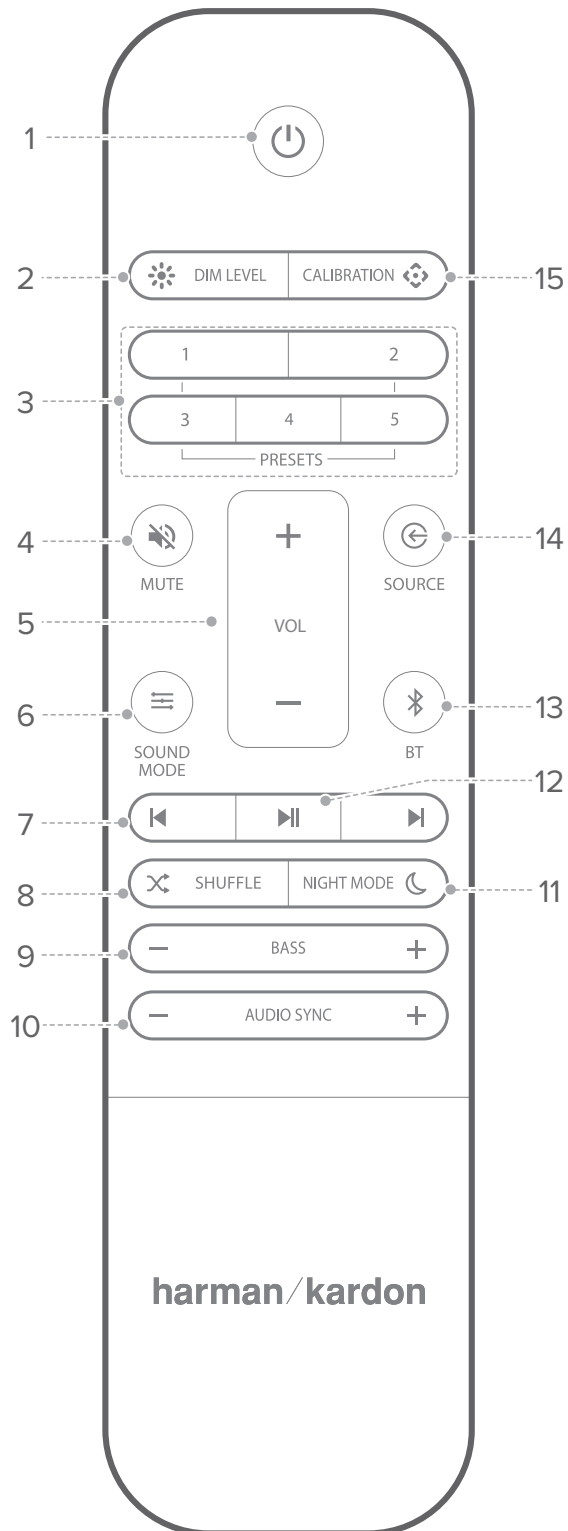



### 1. (Power)

- Power on or switch to standby.

### 2. DIM LEVEL

- Set the brightness of the display panel.

### 3. PRESETS

- Recall preset audio settings and  **SOUND MODE**. To save a preset:
  - Press the  **SOURCE** button to select a source.
  - Press the  **SOUND MODE** button to select a preferred setting for that source.
  - Adjust the **VOLUME**, **BASS** and **NIGHT MODE** to your preference.
  - Press and hold any **PRESET** button for 3 seconds to save all soundbar settings as a preset. Press any **PRESET** button to recall all of the audio settings.

### 4. MUTE

- Mute or unmute the soundbar audio.

### 5. VOL + / -

- Increase or decrease the volume level.

## 6. SOUND MODE

- Select preset sound modes to suit your music or video: **STANDARD / MUSIC / MOVIE / VOICE / PERSONAL**.
- Select the **STANDARD** mode to enjoy the original sound with MultiBeam Surround Sound.
- Select the **MUSIC** mode to enjoy music sound with a light MultiBeam Surround Sound effect.
- Select the **MOVIE** mode to enjoy movie sound with MultiBeam Surround Sound.
- Select the **VOICE** mode to enhance dialogue with a light MultiBeam Surround Sound effect.
- Select the **PERSONAL** mode to enjoy the original sound with MultiBeam Surround Sound. The bass setting can be changed to a personal preference and saved in the preset.
- Press and hold for 5 seconds to reset the default audio settings.

## 7. **SKIP**

- Skip to the previous or next track for Chromecast, Bluetooth or USB playback.

## 8. SHUFFLE

- Repeat or shuffle play (USB playback only).

## 9. **BASS - / +**

- Decrease or increase the bass level of the soundbar (or the subwoofer once successfully paired).

## 10. **AUDIO SYNC - / +**

- Decrease or increase audio sync delay if the video and audio synchronization is not correct.

## 11. **NIGHT MODE**

- Turn the night mode (Dynamic Range Control) on or off for Dolby Digital and DTS tracks. With the night mode turned on, loud sound is reduced (the sound may be distorted).

## 12.

- Play or pause Chromecast, Bluetooth or USB playback.

## 13. BT

- Press to enter Bluetooth pairing mode.
- Press and hold for 5 seconds to connect with a new device.

## 14. SOURCE

- Select an input source for the soundbar: **HDMI ARC / HDMI 1 / HDMI 2\* / HDMI 3\* / Optical / AUX / USB / BT**.

## 15. CALIBRATION

- Press and hold for 3 seconds to initiate Automatic MultiBeam Calibration. (see calibration section)

\* HDMI 2 and HDMI 3 are available on the Enchant 1300 only.

# / INSTALLATION

## Place the Soundbar below your TV on the Table

### NOTES:

- Remove any interference from both sides of the soundbar so the side-firing speakers can operate correctly and reflect sound in your room. Blocking the side horns affects acoustic performance.
- To avoid wireless interference, keep other wireless devices 1-3 ft (0.3-0.9 m) away from the soundbar.
- Make sure there is an AC outlet nearby.

Place the soundbar on its rubber feet on a stable and level surface below your TV.



### CAUTION:

- Do not place the soundbar on its front, back or top when in use.
- Do not place any objects on top of the soundbar.

## Wall-mount the Soundbar

### CAUTION:

- Before mounting on a wall, make sure the wall can support the weight of this unit.
  - Install on a vertical wall only.
  - For the wall-mounting, avoid a location with high temperature or humidity.
  - Connect cables from the unit to external devices before installing on the wall.
  - Make sure the unit is powered off and unplugged before the installation. Otherwise, it may cause an electric shock.
  - Purchase and use the fixing screws or anchors appropriate for the type of wall you have (plasterboard, iron board, wood, etc.). If possible, fix the support screws into wall studs.(Diameter: M5; Length: 1.5 inches or longer recommended)
- 1) Use tape to stick the wall-mounted paper guide on the wall, push a pen tip through the center to mark the wall-mounted bracket location and remove the paper.

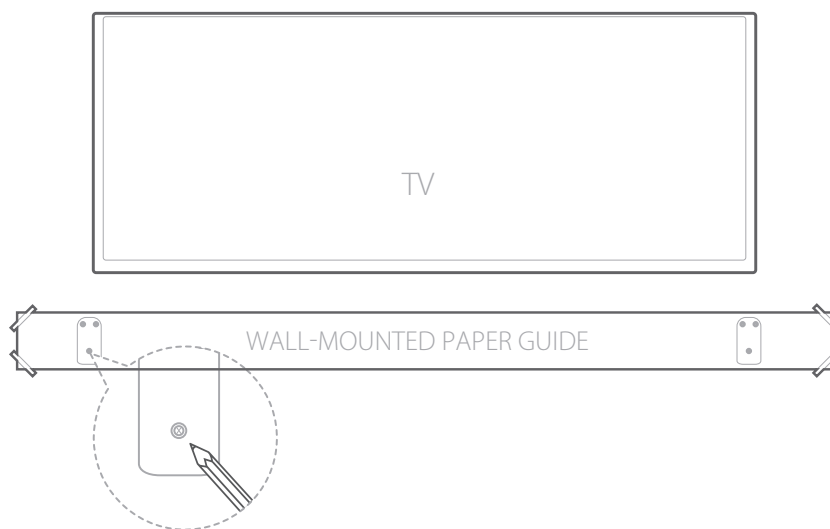



- 2) Use an appropriately sized drill bit, drill a hole in the wall at each marking. Using the appropriate anchors, screw the wall mount brackets into the support screw holes in the wall.

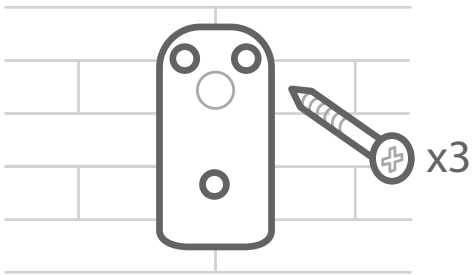

**CAUTION:**

- If the markings do not correspond to the positions of studs, make sure to insert appropriate anchors or mollies into the holes before inserting the support screws. If you use anchors or mollies, make sure the holes you drill are large enough for the anchors or mollies you use.

- 3) With the supplied small screws, fix the L-Brackets to the bottom of the soundbar.

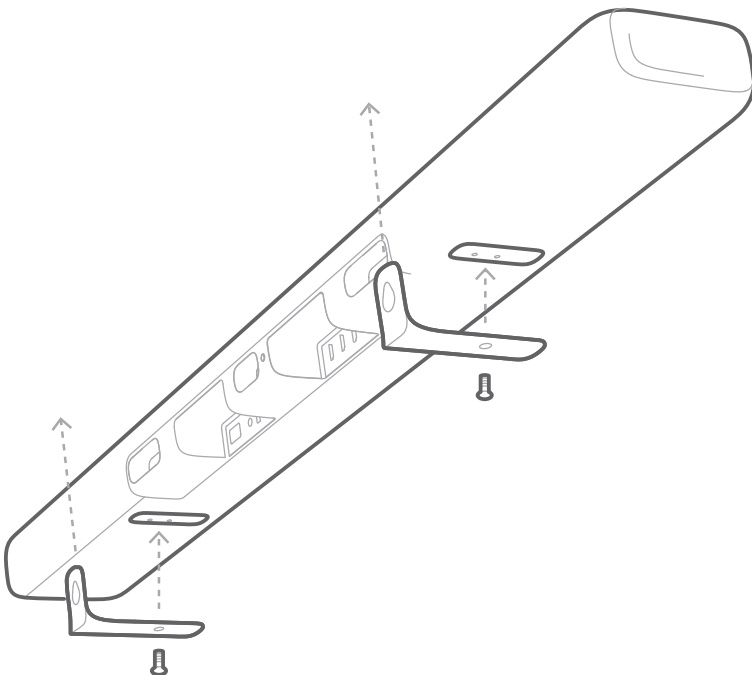

4) Hook the soundbar to the brackets attached to the wall.

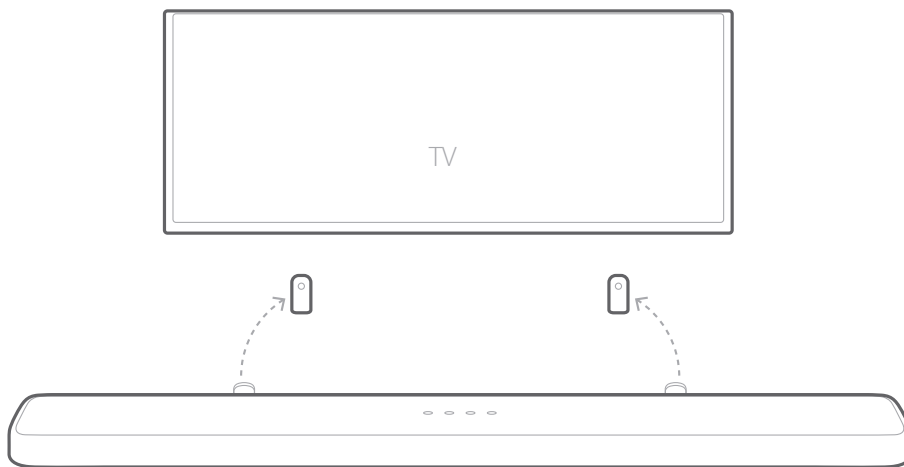

**CAUTION:**

- Do not connect the power cord of the soundbar or your TV to a wall outlet until all connections between components are complete.
- Before moving or installing the unit, make sure to power off and unplug first.

# / CONNECTING TO YOUR TV

## NOTES:

- If you want to enjoy sound only from the soundbar, make sure to set your TV audio settings to support external speakers and disable the built-in TV speakers.
- Before you make or change any connections, make sure that all devices are disconnected from the power outlet.

## Connect to your TV with an HDMI Cable (Preferred)

- 1) Connect the supplied HDMI cable from the **HDMI OUT (TV ARC)** connector on the back of the soundbar to the **HDMI IN (ARC)** connector on your TV.

### ENCHANT 1300



### ENCHANT 800

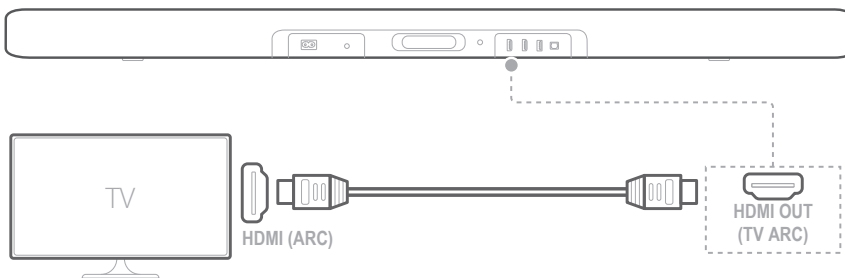

- 2) Press the  button on the top panel of the soundbar or the **SOURCE** button on the remote control to select the TV ARC mode.

**NOTES:**

- An HDMI connection supports digital audio and video with a single connector. It is the best option to connect to your soundbar.
- If your TV features an HDMI ARC connector, you can hear the TV audio through your soundbar by using a single HDMI cable.
- This HDMI connection is required if you intend to connect other video devices to the soundbar inputs to display on your TV.
- On your TV, turn on HDMI-CEC operations. HDMI-CEC is a feature that enables CEC compliant devices that are connected through HDMI to be controlled by a single remote control, such as volume control for both the TV and the soundbar. See the user manual of your TV for details.

**Connect to your TV with an Optical (Digital) Cable****NOTES:**

- Make sure you have removed the protective cap from both ends of the optical cable.
- 1) Connect the **OPTICAL IN** connector on the soundbar to the **OPTICAL OUT** connector of your TV with the provided digital optical cable.

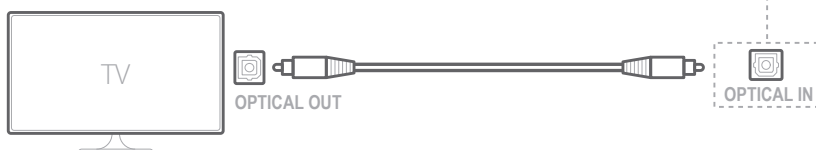
**ENCHANT 1300****ENCHANT 800**

- 2) Press the **⏮** button on the top panel of the soundbar or the **⏮ SOURCE** button on the remote control to select the **OPTICAL** mode.

# CONNECTING TO OTHER DEVICES

## HDMI Cable (Preferred)

Connect a digital device such as a set-top box, DVD/Blu-ray player, or games console to your soundbar through a single HDMI connection.

- 1) Connect the HDMI cable from the **HDMI IN** jack on the back of the soundbar to the **HDMI OUT** jack on your digital device.

### ENCHANT 1300



### ENCHANT 800

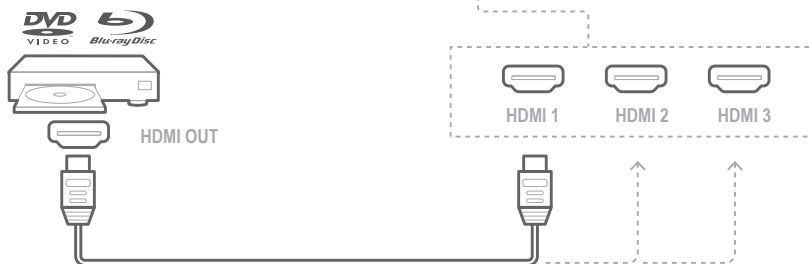

- 2) Press the **Ⓢ** button on the top panel of the soundbar or the **Ⓢ SOURCE** button on the remote control to select the **HDMI** mode.

### NOTES:

- For the best performance, always use a High-Speed (type 2) HDMI cable. See your HDMI cable specifications for more details.

### Optical or Analog Audio Cables

- 1) Connect the **OPTICAL** or **AUX** connector on the soundbar to the **OPTICAL OUT** or **AUDIO OUT** jack of the source device by using the provided optical cable or 3.5mm audio cable.

#### ENCHANT 1300



#### ENCHANT 800

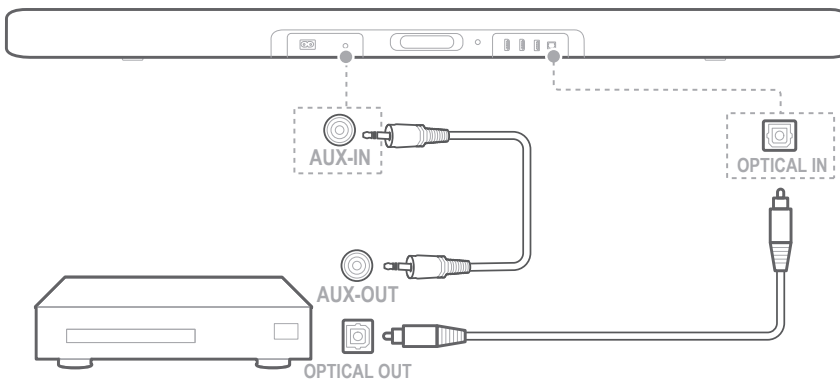

- 2) Press the **⏮** button on the top panel of the soundbar or the **⏮ SOURCE** button on the remote control to select the **OPTICAL** or **AUX** mode.

# CONNECTING TO POWER

## Power On the Soundbar

### NOTES:

- Before connecting the power cord, make sure all other connections have been completed.
- The **⏻ (Power)** button will begin working in 4 to 6 seconds after plugging in the AC power cord.
- When you disconnect the power cord, always pull the plug, never the cable.
- Do not connect this unit or other components to an AC outlet until all connections between components are complete.

### ENCHANT 1300



### ENCHANT 800

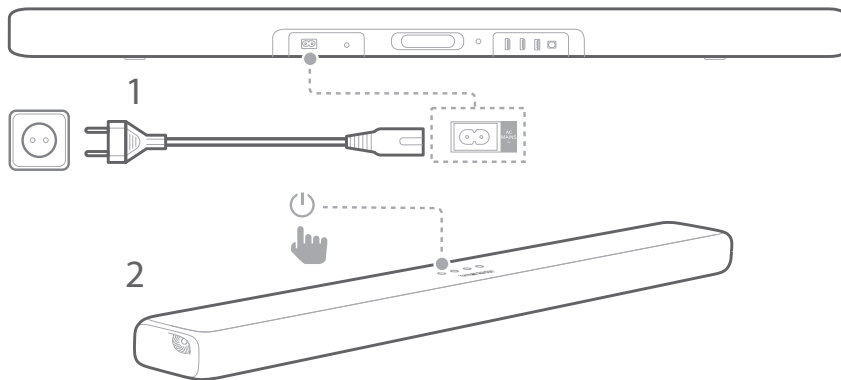

- 1) Plug one end of the power cord into the **AC IN** connector on the back of the soundbar.

- 2) Plug the other end of the power cord into a live AC (mains) wall socket.
  - **“LOADING”** scrolls on the display panel. The soundbar will take about 30 seconds to load, then enter standby mode and ready for use.
- 3) Slide the battery compartment cover until it is completely removed. Insert the two provided AAA 1.5V batteries with correct polarity orientation. Slide the cover back into position.
- 4) Press **⏻ (Power)** to power on the soundbar.
  - **“ON”** is displayed.

### Power On the Subwoofer (Optional)

- 1) Plug one end of the power cord into the **AC IN** connector on the back of the subwoofer.
- 2) Plug the other end of the power cord into a live AC (mains) outlet.

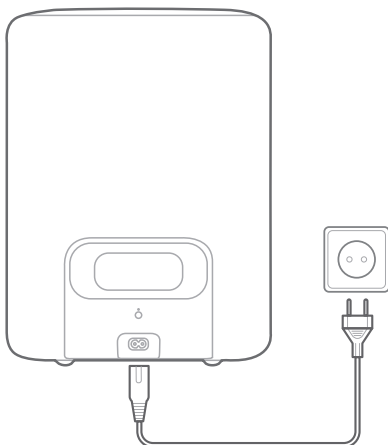



## Connect the Subwoofer (Optional)

- 1) Power on both the soundbar and the subwoofer.
- 2) Press the **SUBWOOFER PAIRING** button on the soundbar or **PAIRING** button on the subwoofer to enter pairing mode.
  - “**SUB PAIRING**” will be displayed. You will hear a pairing chime once connected and “**SUB PAIRED**” will be displayed.

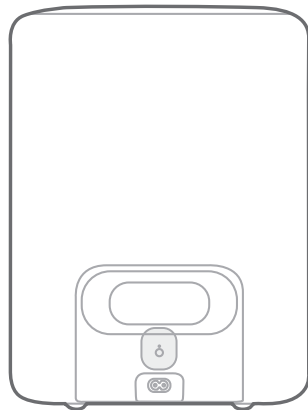



### ENCHANT 1300

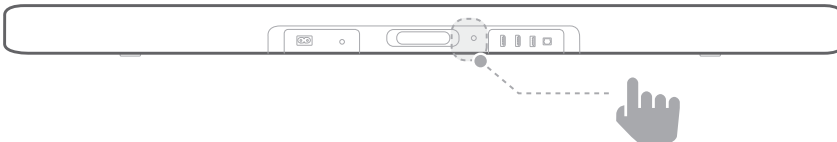

### ENCHANT 800



### Subwoofer LED behavior

-  **White (Flashing slowly):** Powered on
-  **White (Flashing fast):** Pairing
-  **White (Solid):** Paired

**NOTES:**

- If the soundbar is powered off, the subwoofer will enter standby mode.
- If you use a device that uses the same frequency (2.4GHz) as the soundbar near your soundbar, interference may cause some sound interruption.
- The maximum transmission distance of the wireless signal between the soundbar and the subwoofer may vary depending on your operating environment.

# / CONNECTING TO WI-FI

The soundbar is connected to Wi-Fi with the Google Home app.

- 1) Download the Google Home app.
- 2) Power on the soundbar.
- 3) Open the Google Home app and set up your soundbar as instructed in the app. Always follow the instructions in the app to complete the Wi-Fi setup.
- 4) Sign in with your Google account. If you do not have, create a new one.

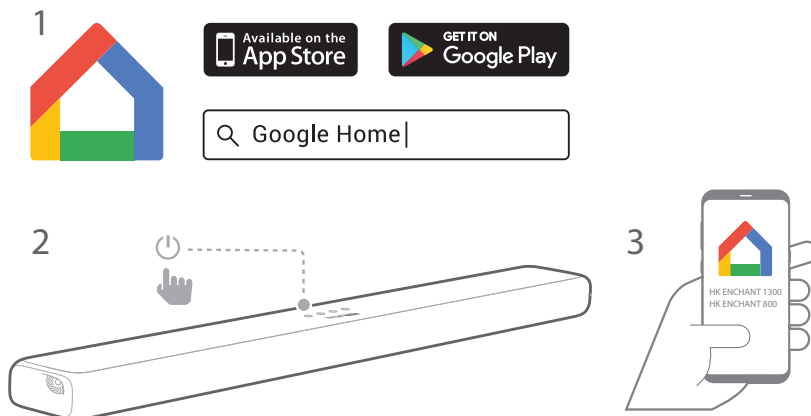

## NOTES:

- If you encounter any setup issues, make sure to enable Bluetooth and location services on your smartphone or tablet.
- Once the soundbar is connected to the Internet for the first time, it may detect a software update to improve performance. This update may take a few minutes to complete.
- In the Google Home app, you can rename the soundbar. The device name will remain during Bluetooth device discovery and Google Cast streaming.
- Once the soundbar is connected to Wi-Fi, it will receive a periodic over-the-air software update to improve performance.
- To disconnect from the Wi-Fi router and reset the soundbar Wi-Fi settings first turn the soundbar on, then press and hold the  button on the soundbar top panel for 5 seconds.

# / USING YOUR SOUNDBAR

## Play Music with Google Cast



With Chromecast built into your Enchant soundbar, you can stream music, podcasts, and playlists from 300+ music apps to your soundbar by simply tapping the **Cast** button.

- 1) Open any Chromecast-compatible app on your smartphone or tablet.
- 2) Tap the  icon on the app and select the Enchant soundbar.
- 3) Press “**Play**” on the app.

### NOTES:

- The name of your soundbar is assigned during the Wi-Fi setup.
- Use the Google Home app to group the soundbar and other Chromecast audio devices together for multi-room music throughout your home.
- The soundbar can support audio streaming and cannot support video streaming.

## Play Music through Bluetooth

- 1) Press  **BT** button on the remote control to enter Bluetooth pairing mode. Alternatively, repeatedly press  **SOURCE** until “**BT**” appears on the display panel.

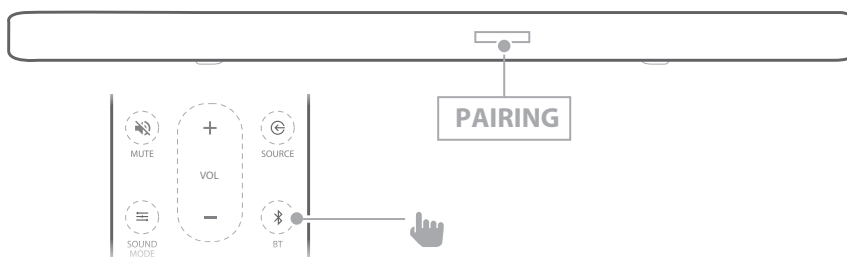

- 2) Choose **“HK ENCHANT 1300/800”** to connect.
  - When the music is streamed, the track, title and artist of the song will scroll on the display panel.

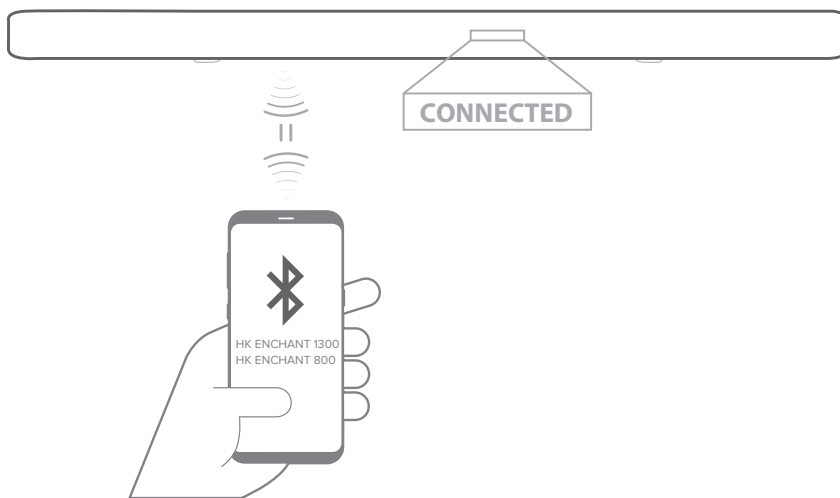

#### NOTES:

- If you have already connected the soundbar to Wi-Fi and changed the device name, then select the new device name.
- If asked for a PIN code when connecting a Bluetooth device, enter “0000”.
- To exit Bluetooth mode, choose other sources.
- To disconnect and pair another device, press and hold **BT** on the remote control for 5 seconds.
- The soundbar automatically turns off after 10 minutes of inactivity.
- Bluetooth performance can be affected by the distance from your device to the soundbar and environment of operation.
- Keep a distance of less than 10m/33ft between the soundbar and your Bluetooth device to avoid disconnection.



## Play Music from USB Storage Device

Play music files located on USB storage devices through the soundbar.

- 1) Plug your USB storage device into the USB socket of the soundbar.

- 2) Press the  button on the top panel of the soundbar or the **SOURCE** button on the remote control to select the **USB** mode.
- If USB is detected, “**LOADING**” will be displayed and music will be played automatically. File names will appear on the display panel. If no USB detected, “**PLUG IN USB**” is displayed.

#### USB playback controls

- : Start, pause or resume play.
- : Skip to the previous or next track.
-  **SHUFFLE**:
  - **Off (default)**: play songs in order.
  - **Shuffle**: play songs randomly.
  - **Repeat one**: play a song repeatedly.
  - **Repeat all**: play all songs repeatedly by order of the folder logic.

#### Audio formats

Extension	Codec	Sample rate	Bitrate
WAV	PCM	44.1Khz ~192Khz	<5Mbps
	LPCM	44.1Khz ~192Khz	<5Mbps
	IMA_ADPCM	44.1Khz ~192Khz	<5Mbps
	MPEG	44.1Khz ~192Khz	<5Mbps
	MULAW	44.1Khz ~192Khz	<5Mbps

Extension	Codec	Sample rate	Bitrate
MP3	MPEG1 layer1/2/3	32Khz ~48Khz	32kbps~320kbps
	MPEG2 layer1/2/3	16Khz ~24Khz	8kbps~160kbps
	MPEG2.5 layer3	8Khz ~12Khz	8kbps~160kbps
AAC	MPEG2 LC	8Khz ~96Khz	<576kbps
	MPEG4 LC	8Khz ~96Khz	<576kbps
	HE AAC	8Khz ~96Khz	<576kbps
Flac	Flac	8Khz ~192Khz	<5Mbps
OGG	Vorbis	8Khz ~48Khz	<500kbps

**NOTES:**

- Only file names that contain numbers or English characters can be displayed, otherwise “UNKNOWN” will be displayed.
- “UNSUPPORTED” is displayed when the file format is not supported.
- Do not extract the USB device while in operation.
- For a large capacity USB, it may take longer than a few minutes to be searched. USB with more than 2000 files cannot be supported.
- Devices which require additional program installation connected to a computer are not supported.
- The USB port of the soundbar cannot be connected to a computer and it cannot be used as a storage device.
- The exFAT and NTFS file system is not supported. FAT16/FAT32 systems are available.
- Depending on some devices, it may not be available to recognize the followings on the soundbar: External HDD; Card readers; Locked devices; Hard type USB devices; USB hub; Using USB extension cable; iPhone/iPod/iPad; Android device.

# / Settings

## Calibrate the Soundbar with Automatic MultiBeam™ Calibration (AMC)

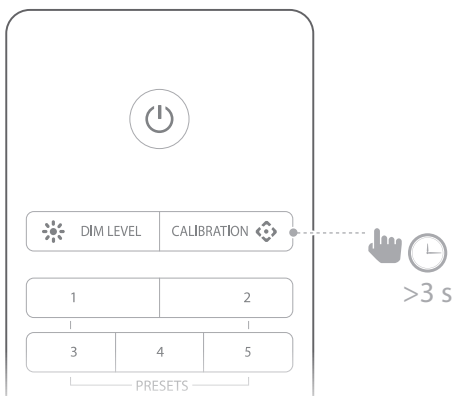

Automatic MultiBeam Calibration (AMC) will optimize the soundbar sound settings for a better surround sound experience.

- 1) Press and hold the **CALIBRATION**  button for 3 seconds.
  - The calibration sequence will begin with a countdown.



- 2) The total calibration will last less than 60 seconds.
  - “**DONE**” will be displayed once successfully calibrated, while “**FAIL**” will be displayed if the calibration fails.

### NOTES:

- Remove any interference from both sides of the soundbar so the side-firing speakers can operate correctly and reflect sound in your room.
- Any ambient noise or sounds may disrupt the calibration sequence. Step out of the way and remain silent during the calibration.
- Calibrate the audio each time you move the soundbar to a different location.
- Calibration settings can be deleted by system reset: press and hold the  and  buttons on the soundbar.



## Respond to TV Remote Control

### HDMI CEC

If you are using an HDMI ARC connection to your television, then your TV remote control will automatically operate the soundbar for standard commands such as power on/off and volume control. The soundbar supports HDMI CEC and will interoperate with compatible TV's (check your TV owner's manual for HDMI CEC compatibility)

### Automatic TV Remote Control

For most Samsung, LG, Sony and Vizio TVs, the soundbar responds to your TV remote control automatically. To disable this function, press and hold the **X SHUFFLE** button on the Enchant remote control for 5 seconds.

### TV Remote Learning

For other TVs, manually program the soundbar to respond to your TV remote control.

- 1) Press and hold **+** and **⌚** for 5 seconds to enter learning mode.

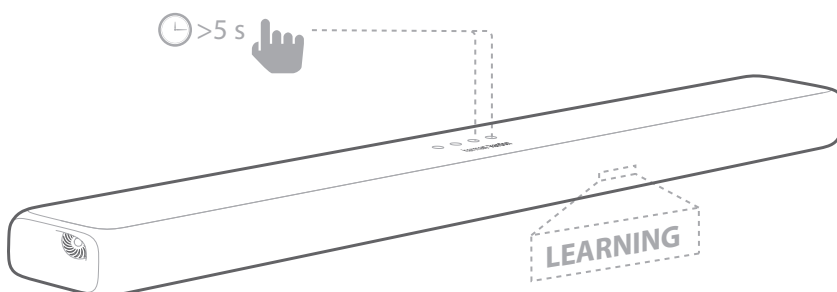

- 2) Press **⏻** button on the soundbar and press **POWER** on your TV remote control.
- 3) Follow the same procedure for volume down and volume up. To mute, press both **+** and **-** on the soundbar and press **MUTE** on your TV remote control.

- 4) Press and hold + and ⏻ on the soundbar again, now the soundbar responds to your TV remote control.

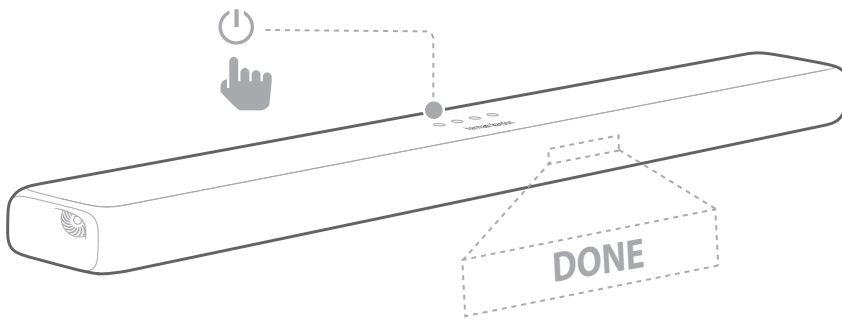

## Auto Standby / Auto Wakeup

This soundbar automatically switches to standby after 10 minutes of button inactivity, and no audio/video playback is detected from a connected device.

This soundbar will automatically power on again if it receives an audio signal from the last detected connection.

## Apply Factory Settings

Reset the soundbar to the default settings programmed at the factory.

- 1) In any source mode, press and hold the ⏻ and ⏪ buttons on top panel of the soundbar.
- 2) When the factory settings restore is complete, the soundbar automatically turns off and restarts.

# / UPDATE SOFTWARE

To get the best features and support, update the soundbar with the latest software. You need:

- Wi-Fi network.
- A computer with Internet access.
- A USB flash drive that is FAT-formatted.

## Check the Current Version

To check the current version, press and hold **⊛ DIM LEVEL** for 3 seconds, then press **☰ SOUND MODE** and **🌙 NIGHT MODE** in sequence within 10 seconds.

## Update the Software

- 1) The latest version of the software can be found when connected to a network. **“NEW UPDATE FOUND”** scrolls once on the display panel. The soundbar starts the update process.
  - Percentage and **“UPDATING, KEEP INTERNET CONNECTION”** scrolls on the display panel.
- 2) Harman Kardon may offer updates for Enchant soundbar’s system firmware in the future. If an update is offered, you can download and store the update file in a USB flash drive and plug into the USB socket of the soundbar. Please visit [www.harmankardon.com](http://www.harmankardon.com) or contact customer service to receive more information about downloading update files. Press and hold the **—** and **🔌** buttons on the soundbar to trigger the software update.

# / SPECIFICATIONS

	Enchant 800	Enchant 1300
<b>Audio/Video</b>		
Audio Channels	8	13
Maximum Power	180W	240W
RMS Power	90W	120W
Total Harmonic Distortion (THD)	1%	1%
Woofer Size	6 x 2" (50mm)	10 x 2" (50mm)
Tweeter Size	2 x 1" (25mm)	1 x 0.75" (20mm) 2 x 1" (25mm)
Max SPL	91db SPL	93dB SPL
Frequency Response	76Hz-20kHz	71Hz-20kHz
Audio inputs	1 Analog, 1 Optical, Bluetooth, USB, Wi-Fi	1 Analog, 1 Optical, Bluetooth, USB, Wi-Fi
HDMI Video Inputs	1	3
HDMI Video Output (with Audio Return Channel)	1	1
HDMI HDCP Version	2.2	2.2
HDR	HDR10	HDR10
<b>Bluetooth</b>		
Bluetooth version	4.2	4.2
Bluetooth Profile	A2DP v1.3/AVRCP v1.5	A2DP v1.3/AVRCP v1.5
Bluetooth Frequency Range	2402MHz-2480MHz	2402MHz-2480MHz
Bluetooth Max Transmitting power	9 dBm (EIRP)	9 dBm (EIRP)
Bluetooth Transmitter modulation	GFSK, $\pi/4$ DQPSK, 8DPSK	GFSK, $\pi/4$ DQPSK, 8DPSK

	Enchant 800	Enchant 1300
<b>Wi-Fi</b>		
Wi-Fi network compatibility	IEEE 802.11b/g/n/ac (2.4G/5G)	IEEE 802.11b/g/n/ac (2.4G/5G)
2.4G Wi-Fi Frequency Range	2412 – 2472MHz (2.4GHz ISM Band, USA 11 Channels, Europe and others 13 Channels)	2412 – 2472MHz (2.4GHz ISM Band, USA 11 Channels, Europe and others 13 Channels)
2.4G Max Transmitting power	18 dBm (EIRP)	18 dBm (EIRP)
2.4G Wi-Fi modulation	OFDM, DSSS, DBPSK, DQPSK, CCK, 16QAM, 64QAM	OFDM, DSSS, DBPSK, DQPSK, CCK, 16QAM, 64QAM
5G Wi-Fi maximum transmitter power	18dBm (EIRP)	18dBm (EIRP)
5G Wi-Fi modulation	OFDM, DSSS, DBPSK, DQPSK, CCK, 16QAM, 64QAM, 256QAM	OFDM, DSSS, DBPSK, DQPSK, CCK, 16QAM, 64QAM, 256QAM
5G Wi-Fi transmitter frequency range	5.150~5.350GHz, 5.470~5.725GHz, 5.725~5.825GHz	5.150~5.350GHz, 5.470~5.725GHz, 5.725~5.825GHz
2.4G short-range wireless frequency range	2402 – 2478MHz	2402 – 2478MHz
2.4G short-range wireless maximum transmitter power	0dBm (EIRP)	0dBm (EIRP)
2.4G short-range wireless modulation	$\pi/4$ DQPSK	$\pi/4$ DQPSK
<b>USB</b>		
USB Compatibility USB Class support	Hi-Speed USB (2.0)	Hi-Speed USB (2.0)
USB File Formats	USB Mass Storage Class (MSC)	USB Mass Storage Class (MSC)

	<b>Enchant 800</b>	<b>Enchant 1300</b>
USB File system	FAT16, FAT32	FAT16, FAT32
USB File Formats	.mp3, .wav, .aac, .flac, .ogg	.mp3, .wav, .aac, .flac, .ogg
USB port	5V --- 1A	5V --- 1A
<b>General</b>		
Power Supply	100-240V~50/60Hz	100-240V~50/60Hz
Power Consumption	33 W	48 W
Standby Power Consumption	<2W	<2W
Operating temperature	0°C - 45°C	0°C - 45°C
Dimensions(W x H x D)	33.8" x 2.6" x 4.9" (860 x 65 x 125mm)	44" x 2.6" x 4.9" (1120 x 65 x 125mm)
Accessory Cable Length	4' (1200mm)	4' (1200mm)
Weight	9.5 lb (4.3 kg)	12.5 lb (5.65kg)
Packaging Dimensions (W x H x D)	37" x 7.5" x 7" (940mm x 190mm x 180mm)	47" x 7.5" x 7" (1200mm x 190mm x 180mm)
Packaging Weight (Gross)	13.4 lb (6.1 kg)	16.7 lb (7.6 kg)

	Enchant Subwoofer
<b>Audio/Video</b>	
Maximum Power	400W
RMS Power	200W
Total Harmonic Distortion (THD)	1%
Woofer Size	6 x 2" (50mm)
Max SPL	83db SPL
Frequency Response	35Hz-160kHz
<b>Wireless</b>	
2.4G short-range wireless frequency range	2402 – 2478MHz
2.4G short-range wireless maximum transmitter power	0dBm (EIRP)
2.4G short-range wireless modulation	$\pi/4$ DQPSK
<b>General</b>	
Power Supply	100-240V~50/60Hz
Power Consumption	48 W
Standby Power Consumption	<0.5W
Operating temperature	0°C - 45°C
Dimensions(W x H x D)	11.7" x 15.7" x 11.7" (296mm x 400mm x 296mm)
Accessory Cable Length	4' (1200mm)
Weight	32.8 lb (14.9 kg)
Packaging Dimensions (W x H x D)	14.1" x 14" x 18.7" (360mm x 358mm x 474mm)
Packaging Weight (Gross)	37 lb (16.8 kg)

# / TROUBLESHOOTING

Never try to repair the product yourself. If you have any problems using this product, check the following points before you request service.

## Sound

### No sound from the soundbar.

- Make sure that the soundbar is not muted.
- Make sure to select the correct audio input source.

### Strange sound.

- Press and hold **≡ SOUND MODE** for 5 seconds to reset the default audio setting.

### No sound from the wireless subwoofer.

- Check if the subwoofer LED is in solid white color. Blinking LED means a disconnection. Manually pair the subwoofer and soundbar.

### Distorted sound or echo.

- If you play audio from the TV through the soundbar, make sure the TV is muted.

### Audio and video are not synchronized.

- Press **AUDIO SYNC +/-** to synchronize.

### Error message is displayed on the display panel.

- When “**ERROR**” is displayed, it indicates that an input audio format is not supported.
- When “**ERROR**” is displayed in USB source mode, it indicates that the USB device or file is not supported.



## Bluetooth

### **A device cannot connect with the soundbar.**

- Check if you enable the Bluetooth function of the device.
- The soundbar is already connected to another Bluetooth device. Press and hold **⌘ BT** on remote control to disconnect and pair with a new device.

### **Poor audio quality from a connected Bluetooth device.**

- The Bluetooth reception is poor. Move the device closer to the soundbar, or remove any obstacle between the device and the soundbar.

## Wi-Fi

### **Enchant soundbar cannot connect to my Wi-Fi network.**

- Check if your router works.
- Follow the instructions in the Google Home app to complete the Wi-Fi setup.



# OPEN SOURCE LICENSE NOTICE

This product contains open source software. For your convenience, the source code and relevant build instruction for software licensed under the GPL is available at <http://www.harmanardon.com/opensource>. You may also obtain this information by contacting us at [OpenSourceSupport@Harman.com](mailto:OpenSourceSupport@Harman.com)

# / LICENSE



The Bluetooth® word mark and logos are registered trademarks owned by the Bluetooth SIG, Inc. and any use of such marks by HARMAN International Industries, Incorporated is under license. Other trademarks and trade names are those of their respective owners.



Manufactured under license from Dolby Laboratories. Dolby, Dolby Audio, Pro Logic and the double-D symbol are trademarks of Dolby Laboratories.



The terms HDMI, HDMI High-Definition Multimedia Interface, and the HDMI logo are trademarks or registered trademarks of HDMI Licensing Administrator, Inc.



The Wi-Fi CERTIFIED Logo is a certification mark of the Wi-Fi Alliance.



For DTS patents, see <http://patents.dts.com>. Manufactured under license from DTS Licensing Limited. DTS, the Symbol, & DTS and the Symbol together are registered trademarks, and DTS Digital Surround is a trademark of DTS, Inc. © DTS, Inc.



The Chromecast built-in logo is a trademark of Google LLC.

**harman / kardon**<sup>®</sup>  
by HARMAN