



JBL Bar 5.1



OWNER'S MANUAL

TABLE OF CONTENTS

1. INTRODUCTION	3	8. AUDIO CALIBRATION	8
2. WHAT'S IN THE BOX	3	9. HOW TO USE YOUR TV REMOTE CONTROL TO CONTROL THE SOUNDBAR	9
3. PLACE YOUR SOUNDBAR	3	FOR MOST SAMSUNG, LG, SONY AND VIZIO TVS	9
PLACE THE SOUNDBAR ON THE TABLE	3	FOR OTHER TVS, DO IR REMOTE LEARNING	9
WALL MOUNT THE SOUNDBAR	4	10. SYSTEM	9
WALL MOUNTING THE SURROUND SPEAKER (OPTIONAL)	4	1. AUTO STANDBY	9
4. CONNECT YOUR SOUNDBAR	4	2. AUTO WAKE UP	9
CONNECTING THE SOUNDBAR TO YOUR TV	4	3. SET DISPLAY BRIGHTNESS	9
CONNECTING THE SOUNDBAR TO OTHER DEVICES	4	4. APPLY FACTORY SETTINGS	9
5. POWER ON YOUR SYSTEM	5	5. CHECK SOFTWARE VERSION	9
PAIR WITH THE SUBWOOFER	5	6. SOFTWARE UPDATE	9
6. USE YOUR SOUNDBAR SYSTEM	5	11. PRODUCT SPECIFICATIONS	10
TO CONTROL	5	GENERAL	10
USING THE WIRELESS SPEAKERS	6	INPUT AND OUTPUT	10
HOW TO USE BLUETOOTH	6	BLUETOOTH SPECIFICATION	10
HOW TO USE SOUNDSHIFT WITH BLUETOOTH	7	USB SPECIFICATION	10
HOW TO USE USB AUDIO	7	PRODUCT DIMENSION AND WEIGHT	10
7. SOUND SETTING	8	WIRELESS TRANSMITTER/RECEIVER SECTION	10
BEFORE YOU START	8	12. TROUBLESHOOTING	10
ADJUST THE VOLUME	8	SYSTEM	10
CHOOSE SOUND EFFECT	8	SOUND	10
1. BASS	8	VIDEO	11
2. SOUND MODE	8	BLUETOOTH	11
3. NIGHT MODE	8	REMOTE CONTROL	11
SYNCHRONIZE VIDEO AND SOUND	8		

1. INTRODUCTION

Thank you for purchasing the JBL Bar 5.1. The JBL Bar 5.1 is designed to bring an extraordinary sound experience to your home entertainment system. We urge you to take a few minutes to read through this manual, which describes the product and includes step-by-step instructions to help you set up and get started.

CONTACT US: If you have any questions about JBL Bar 5.1, its installation or its operation, please contact your retailer or custom installer, or visit our website at www.JBL.com.

2. WHAT'S IN THE BOX

Soundbar



Subwoofer

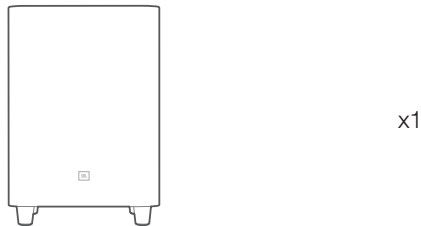

Remote Control and Batteries



Wireless Surround Speakers

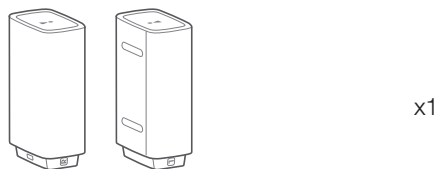

Power Cables* (4ft, 1200mm)



*Power cable numbers varied by regions

HDMI Cable (4ft, 1200mm)



AUX Cable (4ft, 1200mm)



Optical Cable (4ft, 1200mm)



Calibration Microphone



Wall-Mount Brackets



Product Information & Wall-mounted guide



3. PLACE YOUR SOUNDBAR

3a. Place the soundbar on the table

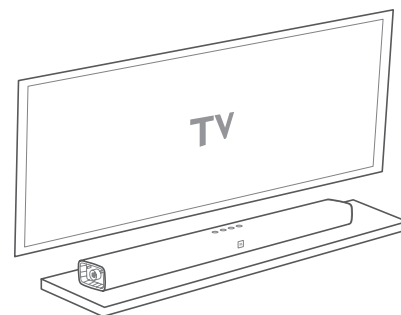

3b. Wall mount the Soundbar

Use tape to stick the wall-mounted paper guide on the wall, push a pen tip through the center of each mounting hole to mark the wall-mounted bracket location and remove the paper.

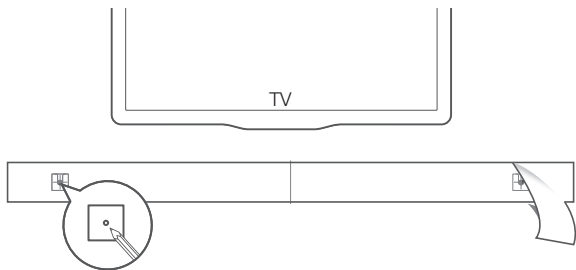

Screw the L-shaped wall mount brackets on the pen mark; screw the threaded mounting post into the back of the soundbar; then hook the soundbar on the wall.

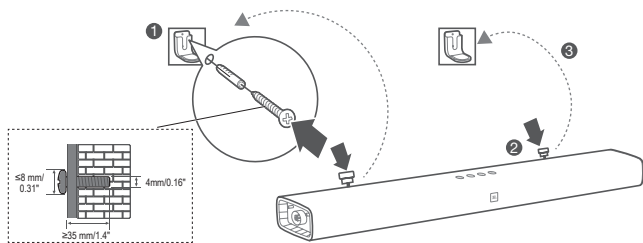

3c. Wall mounting the Surround Speaker (optional)

1. Choose a location to mount the surround speakers. In a standard surround sound configuration, the best locations are the sides or behind the main seating area.
2. Screw the small wall mount brackets to the wall in the desired location
3. Hook the surround speakers to the bracket

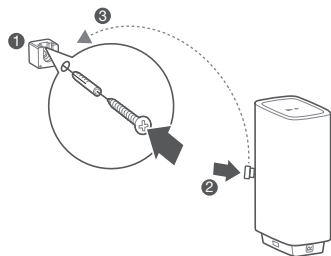

4. CONNECT YOUR SOUNDBAR

This section helps you connect your soundbar to a TV and other devices, and set up the whole system.

Connecting the Soundbar to your TV

Connect your soundbar to a TV. You can listen to audio from TV programs through your soundbar.

Connecting to TV through HDMI (ARC)

An HDMI connection supports digital audio and is the best option to connect to your soundbar. If your TV supports HDMI ARC, you can hear the TV audio through your soundbar by using a single HDMI cable. This HDMI connection is required if you intend to connect other video devices to the soundbar inputs to display on your TV.

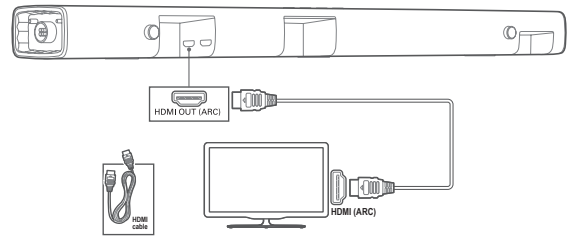

Note: Do confirm that the HDMI CEC function on your TV is turned on.

Connect to TV through Optical

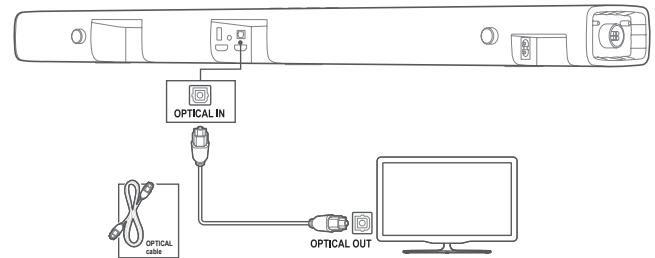

An Optical connection supports digital audio and is an alternative to an HDMI audio connection. An optical audio connection can typically be used if all of your video devices are connected directly to the television--not through the soundbar HDMI inputs.

Note: Confirm to set your TV audio settings to support “external speakers” and disable the built-in TV speakers.

Connecting the soundbar to other devices

Option 1: Connect digital devices through HDMI

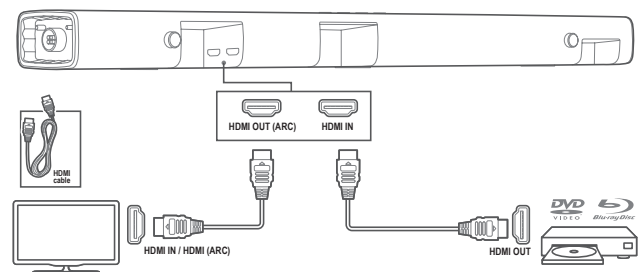

Connect a digital device such as a set-top box, DVD/Blu-ray player, or games console to your soundbar through a single HDMI connection. When you connect the devices in this way and play a file or game, the

- video is automatically displayed on your TV, and
- audio is automatically played on your soundbar.

Using a High Speed HDMI cable, connect the HDMI OUT connector on your digital device to the HDMI IN on your soundbar. Connect your soundbar to TV through HDMI OUT (ARC).

Option 2: Connect devices through analog audio cables

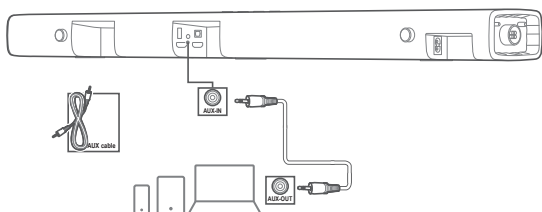

1. Some devices may not feature a digital audio connection. If your device features both digital and analog audio connections, a digital connection is preferred--do not connect both digital and analog at the same time. Using an analog cable, connect the AUX IN (3.5mm jack) on your SoundBar to the AUX IN/ 3.5mm connectors on your portable devices.
2. Press repeatedly SOURCE button on the remote control until AUX is displayed on the display panel.

5. POWER ON YOUR SYSTEM

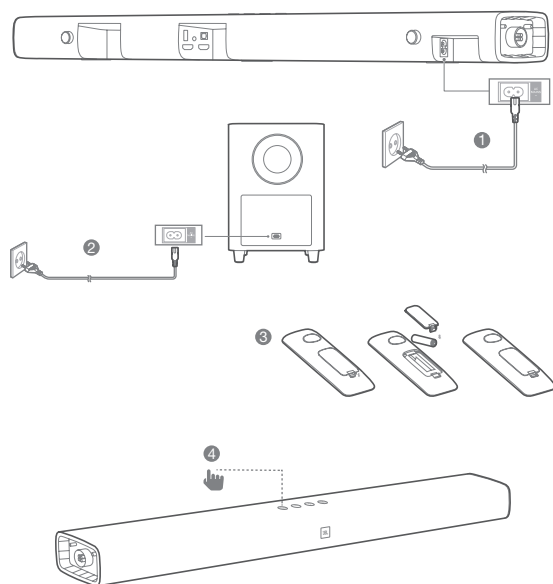

Pairing with the subwoofer

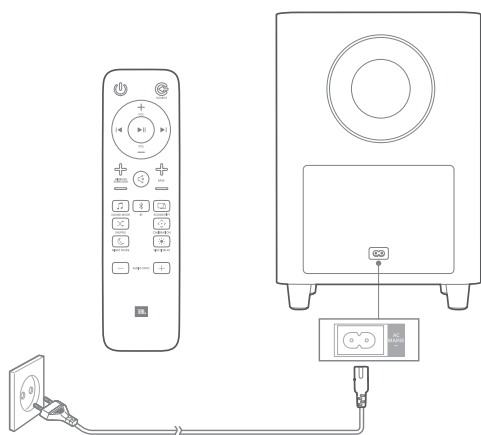

The wireless subwoofer automatically connects with the soundbar when both units are powered on. If the subwoofer is on and connected, the LED lights white continuously.

If no audio from the wireless subwoofer can be heard, manually pair the subwoofer:

1. Turn on the soundbar and the subwoofer. If the connection is lost, the LED indicator on the subwoofer blinks slowly.
2. Press the CONNECT button on the subwoofer to enter pairing mode. The LED indicator on the subwoofer blinks quickly.
3. Press and hold DIM DISPLAY button on remote control for 5 seconds, followed by short press on BASS+, and BASS- button in sequence. Panel display will show "PAIRING"

If the pairing succeeds, the LED indicator on the subwoofer lights up and the soundbar display will show "DONE".

If the pairing fails, the indicator on the subwoofer blinks slowly.

4. If the pairing fails, repeat the steps above.

6. USE YOUR SOUNDBAR SYSTEM

1. How to control your soundbar

a. Top panel

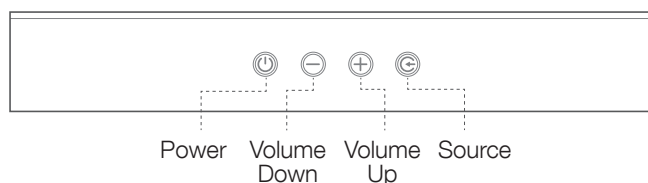

b. Remote Control

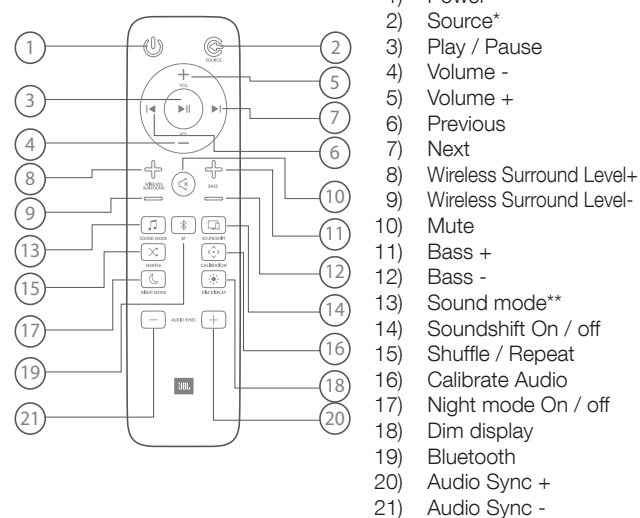

* Switch between HDMI ARC/ HDMI 1/ HDMI 2/ HDMI 3/ Optical/ AUX/ Bluetooth/ USB

** Switch between Standard/ music/voice/ movie/ sports sound mode or press and hold 5 seconds to reset default audio setting

*** For USB playback only; switch between shuffle/ repeat all/ repeat one/ off

2. Using the Wireless Speakers

The JBL Bar 5.1 features two wireless surround speakers that transform the soundbar to a full 5.1 surround sound experience. The soundbar system will reproduce the experience you hear in the movie theater and create an immersive music experience.

How to use your wireless surround speakers:

1. Detach the speakers from the main soundbar and freely place them to the sides or behind the main seating area.

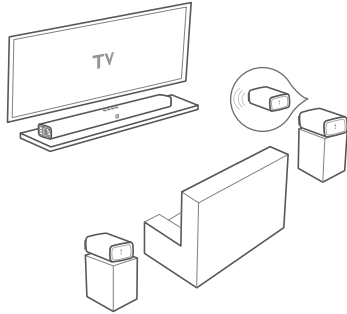

2. Note that the narrow side of the speaker emits the sound. Point this side towards the listening location.

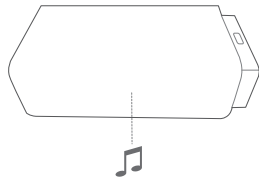

3. The wireless surround speaker volume level is set to a default setting. Press the WIRELESS SURROUND +/- buttons on the remote control to adjust the surround speaker volume level
4. Review the “Audio Calibration” section to calibrate the wireless speaker system to your specific speaker placement and room orientation.

Surround Speaker LED Lighting Indication

- WHITE (Solid) : Connected
- WHITE (Slow Blinking) : Lost connection
- WHITE (Fast Blinking) : Searching for soundbar
- RED (Solid) : Charging
- RED (Blinking) : Low battery

Battery and Charging

- Each wireless surround speaker features 10 hours of playtime.
- Each wireless surround speaker will reach a charge in less than 3 hours of charging.
- Each wireless surround speaker will charge when attached to the soundbar and the system is in STANDBY mode. The surround speakers will stop charging when the soundbar is power ON.
- As an option, each wireless surround speaker can charge via the USB connector, located on the bottom of the speaker.

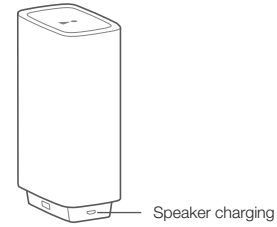

Standby Mode

1. The wireless surround speakers feature standby mode. In this condition the speakers should automatically reconnect to the main soundbar without any other action.
2. The wireless surround speakers automatically enter standby for a total of 10 minutes if one presses POWER OFF on the remote control or the soundbar top-panel buttons.
3. The wireless surround speakers automatically switch to standby after 10 minutes of button inactivity and no audio/video play from a connected device.
4. The wireless surround speakers automatically power off after 20 minutes of button inactivity and no audio/video play from a connected device.

Reconnecting to the Main Soundbar

To re-connect the wireless surround speakers to the soundbar, first confirm the main soundbar is POWER ON, then press the RECONNECT button on the wireless surround speaker.

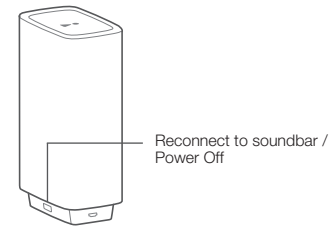

3. How to use Bluetooth

2a. Press Bluetooth (BT) button on your remote control to start Bluetooth pairing

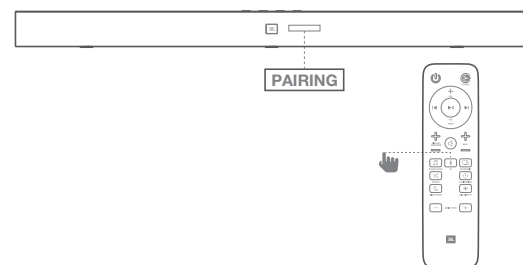

2b. Choose “JBL Bar 5.1” to connect

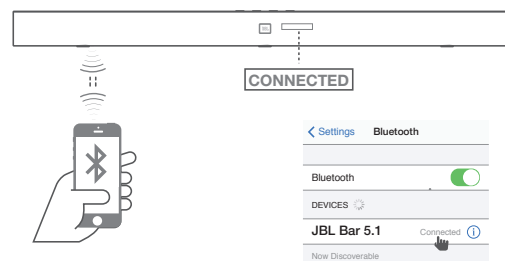

Remark: Press and hold Bluetooth (BT) button on your remote control for 3 seconds if you want to pair another mobile device.

NOTES

- If asked for a PIN code when connecting a Bluetooth device, enter <0000>.
- In Bluetooth connection mode, the Bluetooth connection will be lost if the distance between the Soundbar and the Bluetooth device exceeds 32.8 ft/10m.
- The Soundbar automatically turns off after 10 minutes in the Ready state.
- Electronic devices may cause radio interference. Devices that generate electromagnetic waves must be kept away from the Soundbar main unit - e.g., microwaves, wireless LAN devices, etc.

3. How to use Soundshift with Bluetooth

By default, Soundshift is OFF, Bluetooth music cannot break in your current source. Press SOUNSHIFT button on your remote control to enable Soundshift feature.

While Soundshift is on, play and pause your music source to enjoy auto-switch between your mobile devices - Bluetooth source (A) and TV - Previous source (B).

(A)

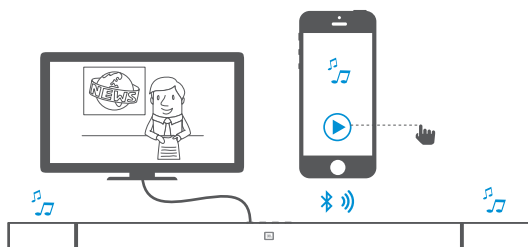

(B)

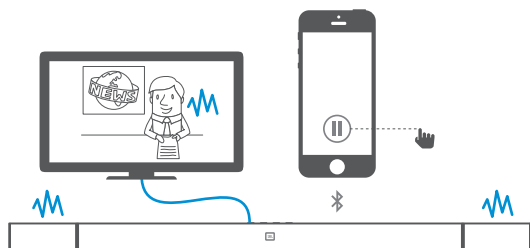

4. How to use USB Audio

Play music files located on USB storage devices through the soundbar.

1. Connect a 2.0 USB drive to this product.
2. Press repeatedly SOURCE button on the remote control until USB is displayed on the display panel.

If USB is detected, display will show LOADING and music start playing automatically.

Songs will appear in the order of the last file added to the USB drive.

How to Control USB playback

Use Play/ Pause/ Previous/ Next/ Shuffle to control USB playback



Button	Action
▶	Start, pause or resume play.
◀/▶	Skip to the previous or next track.
Shuffle	During USB play, press repeatedly to select a repeat or shuffle mode, or turn off a play mode:

Mode	Description	Display
Off	Play songs on USB device on order	OFF
Shuffle	Play songs randomly	SHUFFLE
Repeat once	Play a same song repeatedly	ONE
Repeat all	Play all songs on USB repeatedly by order of the folder logic	ALL

Before you connect a USB device, be aware of the following:

- This soundbar can display file or folder names that contain numbers or English characters only. Other languages and symbol is not supported.
- If the file name of a file on a USB device exceeds 15 characters, it is not displayed on the Soundbar's display.
- Do not remove the USB device while it is transferring files.
- DRM-protected music files (MP3, WMA) from commercial web sites cannot be played.

Compatible USB devices

- MP3 Player : Flash type MP3 player.
- USB Flash Drive : Devices that support USB 2.0.
- Some USB devices may not be supported.

USB device requirement

- Devices which require additional program installation connected to a computer, are not supported.
- Do not extract the USB device while in operation.
- For a large capacity USB, it may take longer than a few minutes to be searched. This unit is not supported when the total number of files is 2000 or more.
- The Soundbar USB Port cannot be connected to PC and it cannot be used as a storage device.
- The exFAT and NTFS file system is not supported on this unit. (FAT16/FAT32 systems are available.)
- Depending on some devices, it may not available to recognize the followings on this unit.

- External HDD
- Card readers
- Locked devices
- Hard type USB devices
- USB hub
- Using USB extension cable
- iPhone/iPod/iPad
- Android device

7. SOUND SETTING

This section helps you choose the ideal sound for your video or music.

Before you start

- Make the necessary connections described in the user manual.
- On the soundbar, switch to corresponding source for other devices.

Adjust the volume

- Press VOLUME +/- button to increase or decrease a volume level.
- To mute sound, press MUTE button.
- To restore the sound, press MUTE button again or press VOLUME +/- button

Choose sound effect

1. Bass

- Change low frequency (bass) settings of the soundbar.
- Press BASS +/- to change the subwoofer volume level.

2. Sound mode

- Select predefined sound modes to suit your video or music.
- Press SOUND button to select a sound option from the display panel.
- Select the **STANDARD** mode if you want to enjoy the original sound.
- Select the **MUSIC, MOVIE, VOICE, SPORT** mode depending on the content you want to listen to.
- When the wireless surround speakers are detached from the main bar, sound modes feature specific behaviors:

Sound Mode	What you hear in the detached wireless surround speakers
Standard	Ambience and special effects
Music	Mono Mix
Movie	Ambience and special effects
Voice	Mono Mix
Sports	Ambience and special effects

3. Night mode

- For quiet listening, night mode decreases the volume of loud sounds when audio is played.
- Night mode is only available for Dolby Digital or DTS soundtracks.
- Press NIGHT MODE button to turn night mode on or off.

Press and hold 5 seconds SOUND button to reset default audio setting.

Synchronize video and sound

- If the audio and video are not synchronized, delay the audio to match the video.
- Press AUDIO SYNC +/- button to synchronize the audio with the video.

8. AUDIO CALIBRATION

Audio Calibration will optimize the wireless speaker sound settings for a better surround sound experience.

Remove the wireless surround speakers from the soundbar.



Connect the microphone into the connector on the right side of the soundbar.

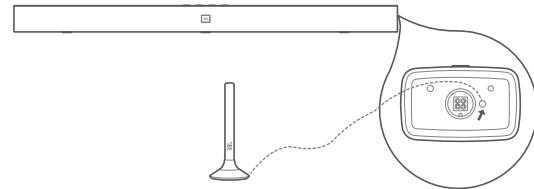

Place the microphone at ear-level at the listening position. For best surround sound effect, position the wireless surround speakers to the sides and slightly behind the listening area.

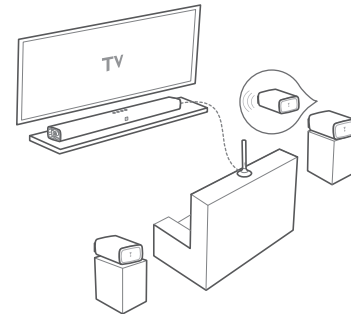

Be sure to point the narrow side of the surround speaker towards the listening area, and remove any obstruction between the microphone and the wireless surround speakers.

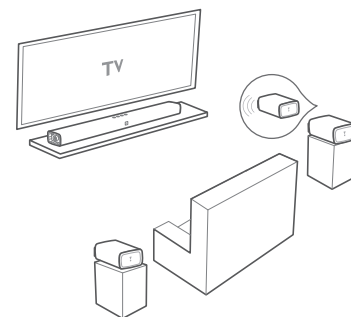

Press and hold the calibration button for 3 seconds. The calibration sequence will begin with a countdown.

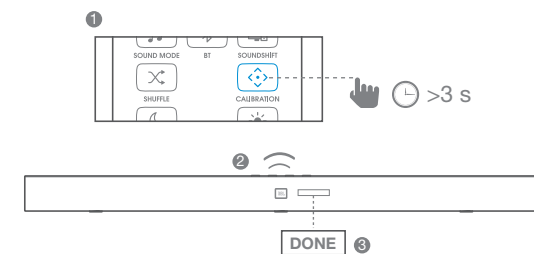

NOTE: any ambient noise or sounds may disrupt the calibration sequence. Step out of the way and remain silent during the calibration.

After the calibration is complete, unplug the microphone and save for later.

NOTE: Audio calibration settings are saved for specific wireless speaker locations. If the wireless speakers are moved to different locations, then the audio calibration settings should be re-measured.

9. HOW TO USE YOUR TV REMOTE CONTROL TO CONTROL THE SOUNDBAR

Use your own TV remote control to control your soundbar

7a. For most Samsung, LG, Sony and Vizio TVs*

The soundbar responds to your TV remote control automatically. Controllable functions are volume up/down and mute. Press and hold SHUFFLE button on soundbar remote control if you want to disable this function.

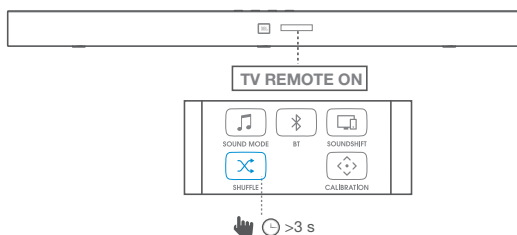

Note:

- Make sure that the sound output of your TV is set to “External speaker”.
- Depending on the remote control, this function may not work well.
- This function does not operate on LG TV’s magic remote control.
- This function may not work well when HDMI CEC is ON.
- Some remote control may not operate if you press repeatedly the volume button.
- If your TV remote control is not supported, follow section 7b and do IR remote learning.

7b. For other TVs, do IR remote learning

To program the soundbar to respond to your TV remote control, follow these steps. First, press and hold VOLUME+ and SOURCE button to enter learning mode.

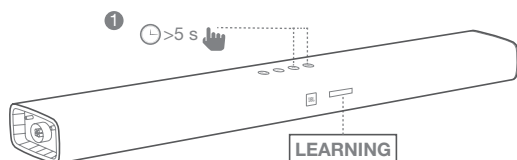

Then, press POWER button on the soundbar and press POWER button on the TV remote control

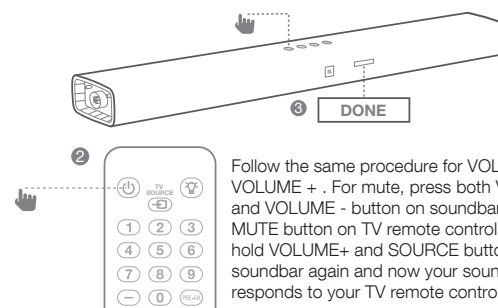

Follow the same procedure for VOLUME - and VOLUME + . For mute, press both VOLUME + and VOLUME - button on soundbar and press MUTE button on TV remote control. Press and hold VOLUME+ and SOURCE button on soundbar again and now your soundbar responds to your TV remote control.

10. SYSTEM

1. Auto standby

This soundbar automatically switches to standby after 10 minutes of button inactivity and no audio/video play from a connected device.

2. Auto wake up

The soundbar is powered on whenever a sound signal is received. This is most useful when connecting to the TV using the optical cable, as most HDMI™ ARC connections enable this feature by default.

3. Set display brightness

Press DIM button on remote control repeatedly to select a different brightness level of the display panel on this product

4. Apply factory settings

- Reset this soundbar to the default settings programmed at the factory.
- In any source mode, press and hold VOLUME -, VOLUME+ and SOURCE button on soundbar top panel until text display shows RESET.
- When the factory settings restore is complete, the product automatically switches off and restarts.

5. Check Software version

- Press and hold DIM DISPLAY button for 5 seconds in any source, Hold and press DIM DISPLAY button for 5 seconds, followed by SOUND MODE and NIGHT MODE button.
- To check subwoofer software version, pls connect subwoofer to soundbar via a 3.5mm AUX in cable and follow the above procedure.

6. Software Update

JBL may offer updates for Soundbar’s system firmware in the future. If an update is offered, you can update the firmware by connecting a USB device with the firmware update stored on it to the USB port on your soundbar.

Please visit www.JBL.com or contact JBL call center to receive more information about downloading update files.

11. PRODUCT SPECIFICATIONS

General

- Total Maximum Power : 510W
- Soundbar Maximum Power : 150W
- Subwoofer Maximum Power : 300W
- Surround Speaker Maximum Power : 30W x 2
- Surround Speaker Play Time : 10 hours
- Battery charge time : <3 hours
- Soundbar Transducer Size : 6 x 2.25" racetrack drivers
3 x 1.25" tweeter
- Subwoofer Transducer Size : 10"
- Max SPL : 104db
- Frequency Response : 35Hz to 20KHz
- Operating Temperature : 0°C - 45°C

Input and Output

- Audio inputs : 1 Analog, 1 Optical, Bluetooth, USB
- HDMI Video Inputs : 3
- HDMI Video Output (with Audio Return Channel) : 1
- HDMI HDCP Version : 2.2

Bluetooth specification

- Bluetooth Version : 4.2
- Bluetooth Profile : A2DP V1.3 / AVRCP V1.6

USB specification

(USB) port: Type A

File Format Type Compatibility list:

Extension	Codec	Sampling Rate	Bitrate
*.mp3	MPEG 1 Layer2	16KHz ~ 48KHz	80kbps~320kbps
	MPEG 1 Layer3	16KHz ~ 48KHz	80kbps~320kbps
	MPEG 2 Layer3	16KHz ~ 48KHz	80kbps~320kbps
	MPEG 2.5 Layer3	16KHz ~ 48KHz	80kbps~320kbps
*.wav	-	16KHz ~ 48KHz	up to 3000kbps

Product dimension and weight

- Soundbar Dimensions (W x H x D) : 1148 x 58 x 93 (mm) \ 45" x 2.3" x 3.7"
- Soundbar Weight : 3.9kg \ 8.6 lbs
- Subwoofer Dimensions (W x H x D) : 440 x 305 x 305 (mm) \ 16" x 12" x 12"

- Subwoofer Weight : 13kg \ 28.7 lbs
- Surround Speaker Dimensions (W x H x D) : 165 x 59 x 93 (mm) \ 6.5" x 2.3" x 3.7"
- Surround Speaker Weight : 0.6kg \ 1.3 lbs
- Packaging Dimensions (W x H x D) : 1008 x 379 x 455 (mm) \ 39.7" x 14.9" x 17.9"
- Packaging Weight (Gross) : 20.95kg \ 46.1 lbs

Wireless transmitter/receiver section

- Bluetooth Frequency Range : 2402MHz-2480MHz
- Bluetooth Max Transmitting power : 9dbm (EIRP)
- Bluetooth Transmitter : GFSK, /4 DQPSK, 8DPSK modulation
- 5.8G Wireless Frequency Range : 5725MHz- 5875MHz
- 5.8G Max Transmitting power : 9dBm (EIRP)

12. TROUBLESHOOTING

If you have problems using this product, check the following points before you request service.

System

The unit will not turn on.

- Check if power cord is plugged into the outlet and the soundbar

Sound

No sound from soundbar.

- Make sure that the soundbar is not muted.
- On the remote control, select the correct audio input source
- Connect the audio cable from your soundbar to your TV or other devices.
 - However, you do not need a separate audio connection when:
 - the soundbar and TV are connected through HDMI ARC connection, or
 - a device is connected to the HDMI IN connector on your soundbar.
- Reset your soundbar to its factory settings via press and hold VOLUME -, VOLUME+ and SOURCE button on soundbar top panel

Sound is strange after sound setting adjustment

- Reset audio setting by press and hold SOUND button on remote control for 5 seconds

No sound from the wireless subwoofer.

- Check if the Subwoofer LED is in solid white colour. If white LED is blinking, connection is lost. Pls manually pair the Subwoofer to soundbar (see 'Pair with the subwoofer' on page 4).

Distorted sound or echo.

- If you play audio from the TV through the soundbar, make sure that the TV is muted.

Audio and video are not synchronized.

- Press AUDIO SYNC +/- to synchronize the audio with the video.

Error message is displayed on the display panel.

- When “ERROR” is displayed, it indicates that an input audio format is not supported.
- When “ERROR” is displayed in USB source, it indicates that the connected USB device or Audio file is not supported

Video**If there is no picture on the TV Screen**

- Check that the soundbar power is ON, the intended source is ON, and the input is set correctly on the soundbar.

Bluetooth**A device cannot connect with the soundbar.**

- You have not enabled the Bluetooth function of the device. See the user manual of the device on how to enable the function.
- The soundbar is already connected with another Bluetooth device. Press and hold BT button on remote control to disconnect the connected device, then try again.
- The device is not correctly connected. Connect the device correctly.

Quality of audio play from a connected Bluetooth device is poor.

- The Bluetooth reception is poor. Move the device closer to the soundbar, or remove any obstacle between the device and the soundbar.

The connected Bluetooth device connects and disconnects constantly.

- The Bluetooth reception is poor. Move the device closer to the soundbar, or remove any obstacle between the device and the soundbar.
- For some Bluetooth device, the Bluetooth connection can be deactivated automatically to save power. This does not indicate any malfunction of the soundbar.

Remote Control**The remote control does not work.**

- Check if the batteries are drained and replace with new batteries.
- If the distance between the remote control and the main unit is too far, move it closer to the unit.

Торговая марка : JBL
Назначение товара : Активная акустическая система
Изготовитель : Харман Интернешнл Индастриз Инкорпорейтед, США, 06901 Коннектикут, г.Стамфорд, Атлантик Стрит 400, офис 1500
Страна происхождения : Китай
Импортер в Россию : ООО "ХАРМАН РУС СиАйЭс", Россия, 127018, г.Москва, ул. Двинцев, д.12, к 1
Гарантийный период : 1 год
Информация о сервисных центрах : www.harman.com/ru тел. +7-800-700-0467
Срок службы : 5 лет
Товар сертифицирован 
Дата производства : Дата изготовления устройства определяется по двум буквенным обозначениям из второй группы символов серийного номера изделия, следующих после разделительного знака «-». Кодировка соответствует порядку букв латинского алфавита, начиная с января 2010 года: 000000-MY0000000, где «М» - месяц производства (А - январь, В - февраль, С - март и т.д.) и «Y» - год производства (А - 2010, В - 2011, С - 2012 и т.д.).



HARMAN International Industries,
Incorporated 8500 Balboa
Boulevard, Northridge, CA 91329
USA
www.jbl.com

© 2017 HARMAN International Industries, Incorporated. All rights reserved. JBL is a trademark of HARMAN International Industries, Incorporated, registered in the United States and/or other countries. Features, specifications and appearance are subject to change without notice. The Bluetooth® word mark and logos are registered trademarks owned by Bluetooth SIG, Inc. and any use of such marks by HARMAN International Industries, Incorporated is under license. Other trademarks and trade names are those of their respective owners. The terms HDMI, the HDMI logo, and High-Definition Multimedia Interface are trademarks or registered trademarks of HDMI Licensing LLC in the United States and other countries. Dolby, Dolby Audio, Pro Logic, and the double-D symbol are trademarks of Dolby Laboratories.

TR04336_A