

**SAMSUNG**

# USER MANUAL

**LS003 SERIES**

**THE  
FRAME**

Thank you for purchasing this Samsung product.



To receive more complete service, please register your product at [www.samsung.com/register](http://www.samsung.com/register)

Model \_\_\_\_\_ Serial No. \_\_\_\_\_

# Before Reading This User Manual

This TV comes with this user manual and an embedded e-Manual.

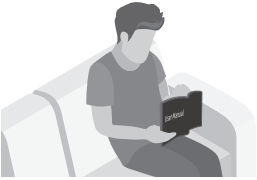
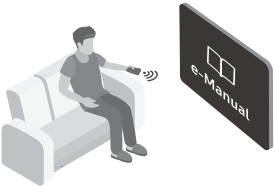

Before reading this user manual, review the following:

	<p><b>User Manual</b></p>	<p>Read this provided user manual to see information about product safety, installation, accessories, initial configuration, and product specifications.</p>
	<p><b>e-Manual</b></p>	<p>For more information about this TV, read the e-Manual embedded in the product.</p> <ul style="list-style-type: none"> <li>To open the e-Manual,           <ul style="list-style-type: none"> <li> &gt;  <b>Settings</b> &gt; <b>Support</b> &gt; <b>Open e-Manual</b></li> </ul> </li> </ul>



On the website, you can download the user manual and see its contents on your PC or mobile device.

## Learning the e-Manual's assistance functions

- Some menu screens cannot be accessed from the e-Manual.







	<p><b>(Search)</b></p>	<p>Select an item from the search results to load the corresponding page.</p>
	<p><b>(Index)</b></p>	<p>Select a keyword to navigate to the relevant page.</p>
	<p><b>(Recent pages)</b></p>	<p>Select a topic from the list of recently viewed topics.</p>

## Learning the functions of the buttons that appear on e-Manual topic pages

	<p><b>(Try Now)</b></p>	<p>Access the associated menu item and try out the feature directly.</p>
	<p><b>(Link)</b></p>	<p>Access a topic referred to on an e-Manual topic page.</p>

# Warning! Important Safety Instructions

Please read the Safety Instructions before using your TV.

<b>CAUTION</b>			Class II product: This symbol indicates that a safety connection to electrical earth (ground) is not required.
<b>RISK OF ELECTRIC SHOCK. DO NOT OPEN.</b>			
CAUTION: TO REDUCE THE RISK OF ELECTRIC SHOCK, DO NOT REMOVE COVER (OR BACK). THERE ARE NO USER SERVICEABLE PARTS INSIDE. REFER ALL SERVICING TO QUALIFIED PERSONNEL.			AC voltage: Rated voltage marked with this symbol is AC voltage.
	This symbol indicates that high voltage is present inside. It is dangerous to make any kind of contact with any internal part of this product.		DC voltage: Rated voltage marked with this symbol is DC voltage.
	This symbol indicates that this product has included important literature concerning operation and maintenance.		Caution. Consult instructions for use: This symbol instructs the user to consult the user manual for further safety related information.

- The slots and openings in the cabinet and in the back or bottom are provided for necessary ventilation. To ensure reliable operation of this apparatus and to protect it from overheating, these slots and openings must never be blocked or covered.
  - Do not place this apparatus in a confined space, such as a bookcase or built-in cabinet, unless proper ventilation is provided.
  - Do not place this apparatus near or over a radiator or heat register, or where it is exposed to direct sunlight.
  - Do not place vessels (vases etc.) containing water on this apparatus, as this can result in a fire or electric shock.
- Do not expose this apparatus to rain or place it near water (near a bathtub, washbowl, kitchen sink, or laundry tub, in a wet basement, or near a swimming pool, etc.). If this apparatus accidentally gets wet, unplug it and contact an authorised dealer immediately.
- This apparatus uses batteries. In your community, there might be environmental regulations that require you to dispose of these batteries properly. Please contact your local authorities for disposal or recycling information.
- Do not overload wall outlets, extension cords, or adaptors beyond their capacity, since this can result in fire or electric shock.
- Power-supply cords should be placed so that they are not likely to be walked on or pinched by items placed upon or against them. Pay particular attention to cords at the plug end, at wall outlets, and at the point where they exit from the appliance.
- To protect this apparatus from a lightning storm, or when left unattended and unused for long periods of time, unplug it from the wall outlet and disconnect the antenna or cable system. This will prevent damage to the set due to lightning and power line surges.

- Before connecting the AC power cord to the DC adaptor outlet, make sure that the voltage designation of the DC adaptor corresponds to the local electrical supply.
  - Never insert anything metallic into the open parts of this apparatus. This may cause a danger of electric shock.
  - To avoid electric shock, never touch the inside of this apparatus. Only a qualified technician should open this apparatus.
  - Be sure to plug in the power cord until it is firmly seated. When unplugging the power cord from a wall outlet, always pull on the power cord's plug. Never unplug it by pulling on the power cord. Do not touch the power cord with wet hands.
  - If this apparatus does not operate normally - in particular, if there are any unusual sounds or smells coming from it - unplug it immediately and contact an authorised dealer or service centre.
  - Be sure to pull the power plug out of the outlet if the TV is to remain unused or if you are to leave the house for an extended period of time (especially when children, elderly, or disabled people will be left alone in the house).
    - Accumulated dust can cause an electric shock, an electric leakage, or a fire by causing the power cord to generate sparks and heat or by causing the insulation to deteriorate.
  - Be sure to contact an authorised Samsung service centre for information if you intend to install your TV in a location with heavy dust, high or low temperatures, high humidity, chemical substances, or where it will operate 24 hours a day such as in an airport, a train station, etc. Failure to do so may lead to serious damage to your TV.
  - Use only a properly grounded plug and wall outlet.
    - An improper ground may cause electric shock or equipment damage. (Class I Equipment only.)
  - To turn off this apparatus completely, disconnect it from the wall outlet. To ensure you can unplug this apparatus quickly if necessary, make sure that the wall outlet and power plug are readily accessible.
  - Store the accessories (batteries, etc.) in a location safely out of the reach of children.
  - Do not drop or strike the product. If the product is damaged, disconnect the power cord and contact a Samsung service centre.
  - To clean this apparatus, unplug the power cord from the wall outlet and wipe the product with a soft, dry cloth. Do not use any chemicals such as wax, benzene, alcohol, thinners, insecticide, aerial fresheners, lubricants, or detergents. These chemicals can damage the appearance of the TV or erase the printing on the product.
  - Do not expose this apparatus to dripping or splashing.
  - Do not dispose of batteries in a fire.
  - Do not short-circuit, disassemble, or overheat the batteries.
  - There is danger of an explosion if you replace the batteries used in the remote with the wrong type of battery. Replace only with the same or equivalent type.
- \* Figures and illustrations in this User Manual are provided for reference only and may differ from the actual product appearance. Product design and specifications may change without notice.

# Contents

	Before Reading This User Manual	2
	Warning! Important Safety Instructions	3
<b>01</b>	<b>What's in the Box?</b>	
<b>02</b>	<b>Connecting the TV to the One Connect</b>	
<b>03</b>	<b>TV Installation</b>	
	Mounting the TV on a wall	8
	Providing proper ventilation for your TV	9
	Attaching the TV to the Stand	9
	Safety Precaution: Securing the TV to the wall to prevent falling	10
	Using the Cover Cap	11
	Detach the Clean Back Cover Terminal from the TV	11
	Precautions when installing the TV with a stand	11
<b>04</b>	<b>Using Art Mode</b>	
	Viewing images	12
	Setting the options	14
	Using Art mode with the Smart View app	15
<b>05</b>	<b>The Samsung Smart Remote</b>	
	Pairing the TV to the Samsung Smart Remote	17
	Installing batteries into the Samsung Smart Remote	17
<b>06</b>	<b>Initial Setup</b>	
	Using the TV Controller	18
<b>07</b>	<b>Connecting to a Network</b>	
	Network Connection - Wireless	19
	Network Connection - Wired	19
	Mobile Network	20
<b>08</b>	<b>Troubleshooting and Maintenance</b>	
	Troubleshooting	21
	Precautions when using Art mode	23
	What is Remote Support?	24
	Eco Sensor and screen brightness	24
	Still image warning	25
	Caring for the TV	25
<b>09</b>	<b>Specifications and Other Information</b>	
	Specifications	26
	Environmental Considerations	26
	Decreasing power consumption	26
	Licences	27

# 01 What's in the Box?

Make sure the following items are included with your TV. If any items are missing, contact your dealer.

- Samsung Smart Remote & Batteries (AA x 2)
- Warranty Card / Regulatory Guide (Not available in some locations)
- TV Power Cable / One Connect Power Cable
- User Manual

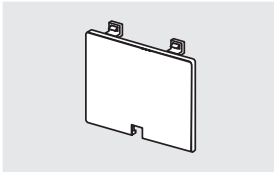

Cover Terminal

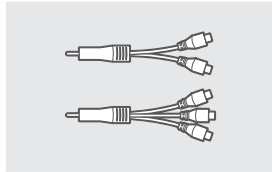

COMPONENT IN / AV IN  
Adapter (Not available in  
some locations)



Bending Cover

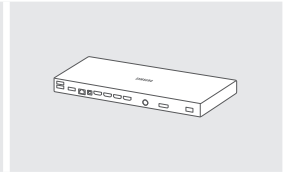

One Connect



Invisible Connection



4EA  
Wall Mount Adapter



Holder-Cable



2EA  
Cover Cap

- The items' colours and shapes may vary depending on the models.
- Cables not included can be purchased separately.
- Check for any accessories hidden behind or in the packing materials when opening the box.



**Warning:** Screens can be damaged from direct pressure when handled incorrectly. We recommend lifting the TV at the edges, as shown.



## 02 Connecting the TV to the One Connect

Refer to the following figure and connect the Invisible Connection, supplied as an accessory, between the TV and the One Connect. Be sure to first untie the cable (Ⓜ) of the Invisible Connection that is connected to the TV. If you untie the cable (⇒) of the Invisible Connection that will be connected to the One Connect, the cable may be entangled or damaged.

1. Connect the connector (Ⓜ) of the Invisible Connection to the TV, and then connect the connector (⇒) to the One Connect.
2. After connecting the Invisible Connection between the TV and the One Connect, connect their power plugs to power outlets.

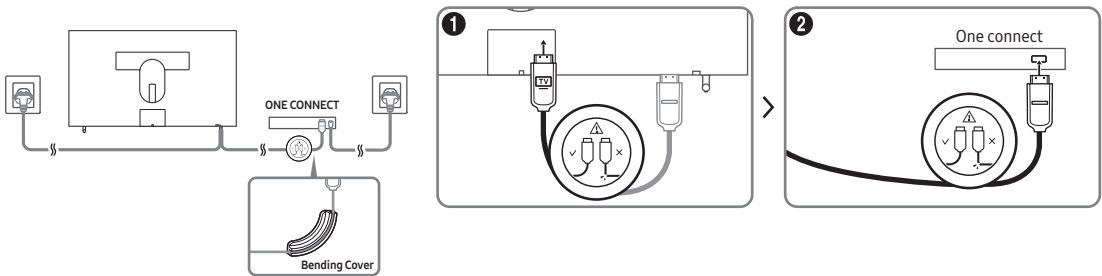

- When connecting the Invisible Connection, use a Bending Cover to prevent the cable of the Invisible Connection from being bent at a 90 degree angle. Failure to do so may cause damage to the cable.
- When connecting the Invisible Connection, pay attention to the shapes of its connectors so that they are connected correctly. Failure to do so may cause product malfunction.
- After connecting the Invisible Connection, wind the remaining cable around the Invisible Connection tube. Just winding or leaving the remaining cable as it is may cause damage to the cable.
- When connecting the Invisible Connection, be careful not to twist the cable of the Invisible Connection. Failure to do so may cause performance degradation to the TV or damage to the cable.
- Be careful not to take the following actions to prevent the Invisible Connection from being damaged:



Bending



Twisting



Pulling



Stepping on



Pressing on

### CLASS 1 LASER PRODUCT

- Caution - Invisible laser radiation when open. Do not stare into beam.
  - Do not bend or cut cables excessively.
  - Do not place heavy objects on the cable.
  - Do not disassemble the connector of the cable.
- Caution - Use of controls or adjustments or performance of procedures other than those specified herein may result in hazardous radiation exposure.

# 03 TV Installation

## Mounting the TV on a wall



If you mount this TV on a wall, follow the instructions exactly as set out by the manufacturer. Unless it is correctly mounted, the TV may slide or fall and cause serious injury to a child or adult and serious damage to the TV.

For models providing wall mount adapters, install them as shown in the figure below before installing the wall mount kit.

- Refer to the installation manual included with the Samsung wall mount kit.
- When installing the No gap Wallmount that comes with the product, do not close the Cover Terminal.

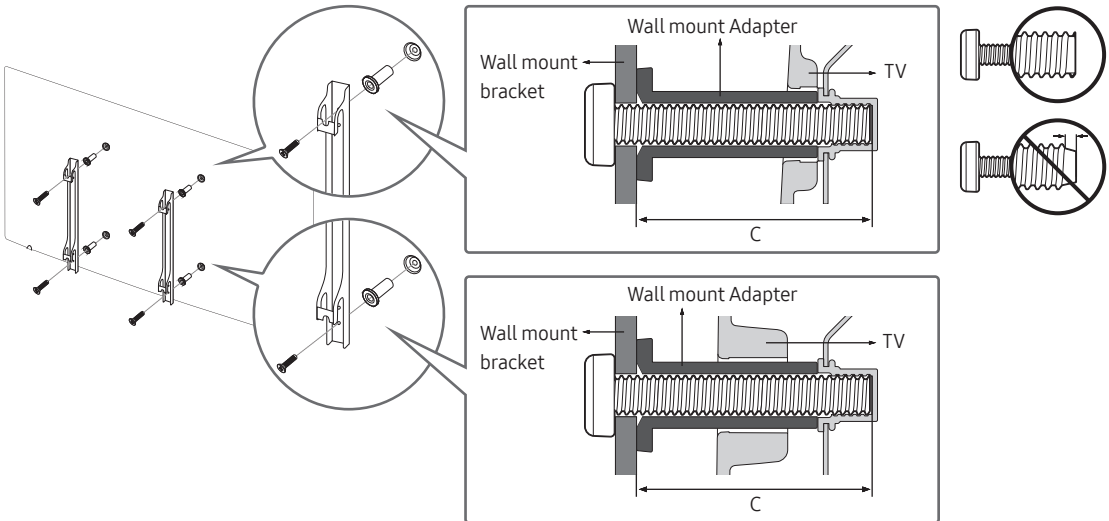

- Samsung Electronics is not responsible for any damage to the product or injury to yourself or others if you choose to install the wall mount on your own.
- You can install your wall mount on a solid wall perpendicular to the floor. Before attaching the wall mount to surfaces other than plaster board, contact your nearest dealer for additional information. If you install the TV on a ceiling or slanted wall, it may fall and result in severe personal injury.
- Standard dimensions for wall mount kits are shown in the table on the next page.
- If you are installing a third-party wall mount, note that the length of the screws you can use to attach the TV to the wall mount is shown in column C in the table on the next page.
- When installing a wall mount kit, we recommend you fasten all four VESA screws.
- If you want to install a wall mount kit that attaches to the wall using two top screws only, be sure to use a Samsung wall mount kit that supports this type of installation. (You may not be able to purchase this type of wall mount kit, depending on the geographical region.)

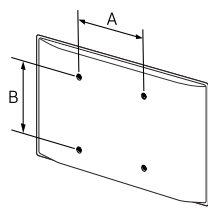

TV size in inches	VESA screw hole specs (A * B) in millimetres	C (mm)	Standard Screw	Quantity	
55 - 65	400 x 400	43 - 45	M8	4	



**Do not install your wall mount kit while your TV is turned on. This may result in personal injury from electric shock.**

- Do not use screws that are longer than the standard dimension or do not comply with the VESA standard screw specifications. Screws that are too long may cause damage to the inside of the TV set.
- For wall mounts that do not comply with the VESA standard screw specifications, the length of the screws may differ depending on the wall mount specifications.
- Do not fasten the screws too firmly. This may damage the product or cause the product to fall, leading to personal injury. Samsung is not liable for these kinds of accidents.
- Samsung is not liable for product damage or personal injury when a non-VESA or non-specified wall mount is used or when the consumer fails to follow the product installation instructions.
- Do not mount the TV at more than a 15 degree tilt.
- Always have two people mount the TV onto a wall.

## Providing proper ventilation for your TV

When you install your TV, maintain a distance of at least 10 cm between the TV and other objects (walls, cabinet sides, etc.) to ensure proper ventilation. Failing to maintain proper ventilation may result in a fire or a problem with the product caused by an increase in its internal temperature.

When you install your TV with a stand or a wall mount, we strongly recommend you use parts provided by Samsung Electronics only. Using parts provided by another manufacturer may cause difficulties with the product or result in injury caused by the product falling.

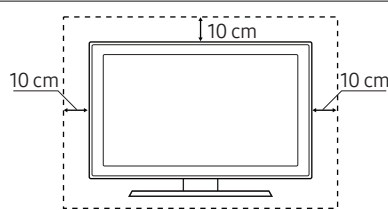
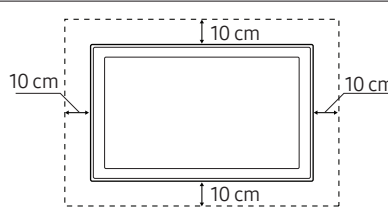
Installation with a stand	Installation with a wall mount
	

## Attaching the TV to the Stand

Make sure you have all the accessories shown, and that you assemble the stand following the provided assembly instructions.

## Safety Precaution: Securing the TV to the wall to prevent falling

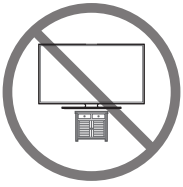

**Caution:** Pulling, pushing, or climbing on the TV may cause the TV to fall. In particular, ensure your children do not hang on or destabilise the TV. This action may cause the TV to tip over, causing serious injuries or death. Follow all safety precautions provided in the Safety Flyer included with your TV. For added stability and safety, you can purchase and install the anti-fall device as described below.



**WARNING:** Never place a television set in an unstable location. The television set may fall, causing serious personal injury or death. Many injuries, particularly to children, can be avoided by taking simple precautions such as

- Using cabinets or stands recommended by the manufacturer of the television set.
- Only using furniture that can safely support the television set.
- Ensuring the television set is not overhanging the edge of the supporting furniture.
- Not placing the television set on tall furniture (for example, cupboards or bookcases) without anchoring both the furniture and the television set to a suitable support.
- Not placing the television set on cloth or other materials that may be located between the television set and supporting furniture.
- Educating children about the dangers of climbing on furniture to reach the television set or its controls.

If you are retaining and relocating the television set that you are replacing with this new set, you should apply the same precautions to the old set.

- When you have to relocate or lift the TV for replacement or cleaning, be sure not to pull out the stand.

### Preventing the TV from falling

1. Using the appropriate screws, firmly fasten a set of brackets to the wall.  
Confirm that the screws are firmly attached to the wall.
  - You may need additional material such as wall anchors depending on the type of wall.
2. Using the appropriately sized screws, firmly fasten a set of brackets to the TV.
  - For the screw specifications, refer to the standard screw part in the table under "Mounting the TV on a wall".
3. Connect the brackets fixed to the TV and the brackets fixed to the wall with a durable, heavy-duty string, and then tie the string tightly.
  - Install the TV near the wall so that it does not fall backwards.
  - Connect the string so that the brackets fixed to the wall are at the same height as or lower than the brackets fixed to the TV.

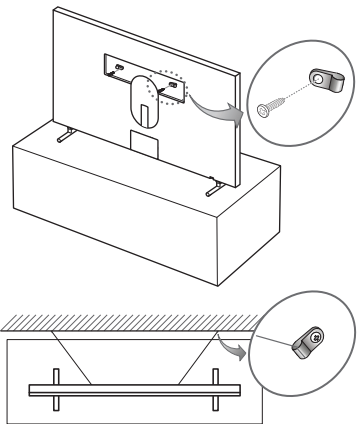

## Using the Cover Cap

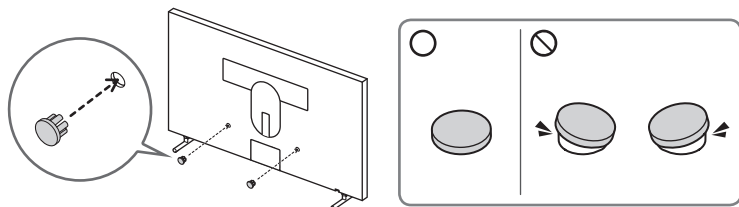

## Detach the Clean Back Cover Terminal from the TV

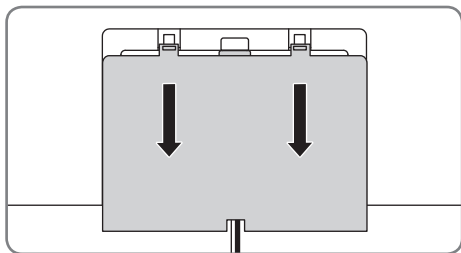

## Precautions when installing the TV with a stand

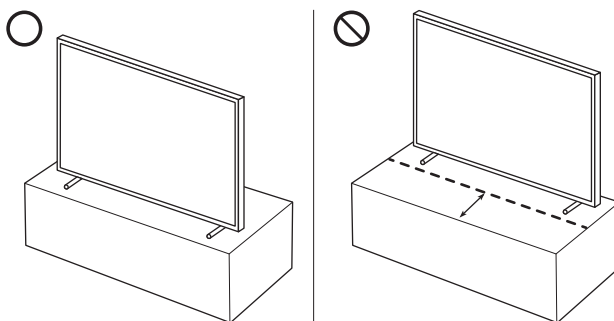

When you install the TV with a stand, avoid placing the stand on the back part of the table surface. Failure to do so may cause the motion sensor not to work properly.

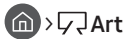

# 04 Using Art Mode



You can use the Art mode function to display image content such as artworks or pictures when you are not watching TV in full screen mode.

- Press the  button on the remote control to switch to TV mode or Art mode.
- Press the  button in Art mode to switch to TV mode.
- When you select a photo, you can enjoy it in Art mode.
- To turn off the TV completely, press and hold the  button on the remote control, or press the power button at the bottom of the TV.
  - If you use a remote control other than a Samsung TV remote control, the TV may not be turned off completely.
- In Art mode, the brightness and colour tone of your TV are automatically adjusted depending on the ambient, and the TV can be automatically turned on or off.
  - The TV is set by default so that the screen turns off automatically when the ambient light dims in Art mode.
- You can use the **Smart View** app on your mobile device to set the motion sensor settings so that the TV can detect visual changes including user movements and turn on or off automatically.
- In Art mode, you can connect your mobile device to the TV via Bluetooth to listen to music on the mobile device.
  - Turn on the **Sound Mirroring** function in the **Smart View** app on the mobile device.  
(The features or terminology may vary depending on the version of the **Smart View** app.)
  - Turn on Bluetooth on your mobile device, and then select the TV you want to connect to.

## Viewing images

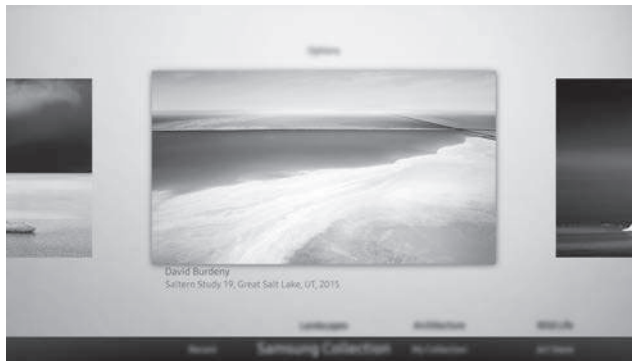

To view an image in Art mode, select one of the menus below. To switch to the sub mode where you can select images, press the Select button, one of the four directional buttons, or  button in Art mode. Then, use the directional buttons on the remote control to move to an image, and then press the Select button. You can view the selected image in the Art mode.

- **Recent**

You can manipulate the last selected image.

- **Samsung Collection**

You can choose images from different topics.

- **My Collection**

You can also select the desired images from an external storage or mobile device and then save them in **Photos** under **My Collection**.

- In order to fetch the images from your mobile device, the Smart View app must have been installed in your mobile device.

- **Art Store**

You can go to **Art Store** to purchase various images.

- The **Art Store** may not appear depending on the network connection status.

## Import images from an external storage device

1. Connect an external storage device that contains images to the TV.
  2. Use the directional buttons on the remote control to move to **My Collection**, and then move to the connected external storage device.
  3. Use the directional buttons on the remote control to move to **Options** at the top of the screen, and then select **Save**.
  4. Use the directional buttons on the remote control to move to an image, and then press the Select button.
    - You can select multiple images.
  5. Use the directional buttons on the remote control to move to **Save Selected** at the top of the screen, and then press the Select button.
  6. The selected image or images are saved in **My Collection > Photos**
- Recommended resolutions: 3840 x 2160 (16:9)

## Buying images from Art Store

1. Use the directional buttons on the remote control to move to **Art Store**.
2. Use the directional buttons on the remote control to move to a topic, and press the Select button. The images corresponding to the topic appear on the screen.
3. Use the directional buttons on the remote control to move to an image.
4. Use the directional buttons on the remote control to move to **Options** at the top of the screen, and then press select the price item.
5. Use the directional buttons on the remote control to move to a payment method, and then press the Select button.

## Subscribing to Art Store Membership

When you subscribe to **Art Store Membership**, you can use **Art Store** unlimitedly and enjoy various art works by replacing them with new ones according to your preferences.

1. Use the directional buttons on the remote control to move to **Art Store > Membership**.
2. Use the directional buttons on the remote control to select **Art Store Membership**.
3. Follow the on-screen instructions to enter your membership information.

## Setting the options



Use the directional buttons on the remote control to move to **Options** at the top of the screen. You can use the following menus:

- **Info**  
You can find more information about the image.
- **Mount**  
You can apply various border styles and colours to the image according to your preferences.

### Apply a border style and a colour to an image

1. Using the directional buttons on the remote control to move to the image whose border style and colour you want to change, move to **Mount** at the top of the screen, and then press the Select button.
2. Use the directional buttons on the remote control to select the border style and colour that you want.
3. To save the selected border style and colour, change the border style and then select the image.
  - If you press the  button to exit, the border style and colour you changed are not saved.

## Using Art mode with the Smart View app

Once you have installed the **Smart View** app on your mobile device, you can use the following functions:

You can download the **Smart View** app from Google Play Store, Samsung Apps, or the App Store.

- The features or terminology may vary depending on the version of the **Smart View** app.
- On tablet devices, the Art mode features may not be supported by the **Smart View** app.
- **Selecting and buying images**
- **Subscribing to Art Store Membership**
- **Creating Collage:** Combine multiple images into one image.
- **Applying border styles and colours to images**
- **Setting the colour tone and the brightness for Art mode**
- **Setting Sleep After:** When no motion is detected for the time specified in Art mode, the TV turns off automatically.
- **Setting Night Mode:** Set The Frame to turn off automatically if no light is detected in the room.
- **Setting Motion Detector Sensitivity:** Set the sensor sensitivity so that the TV turns on automatically when motion is detected in Art mode.
- **Setting Sound Mirroring:** You can use the TV speaker as a Bluetooth speaker in Art mode.

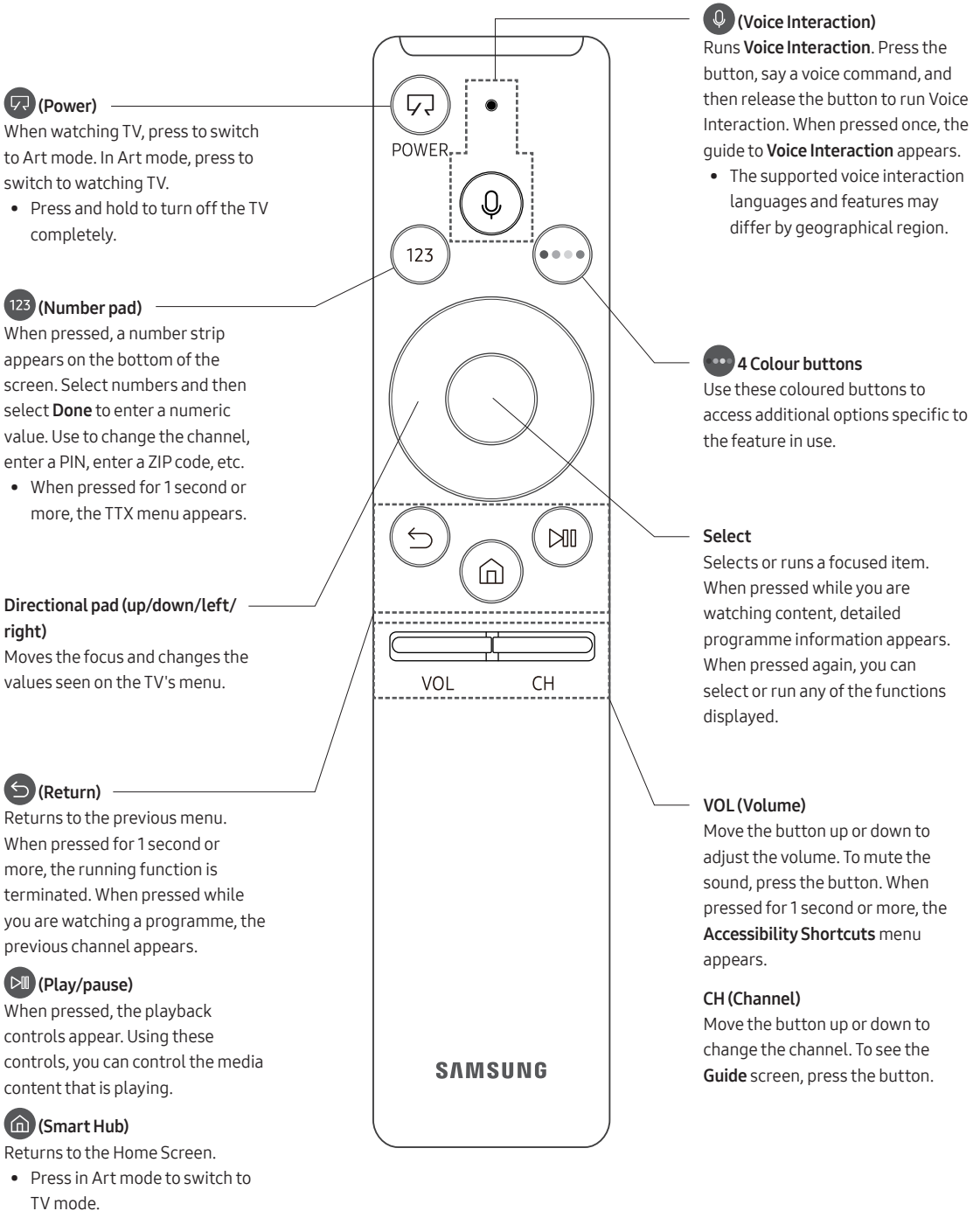

# 05 The Samsung Smart Remote



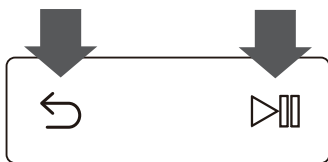

## Pairing the TV to the Samsung Smart Remote



When you turn on the TV for the first time, the Samsung Smart Remote pairs to the TV automatically. If the Samsung Smart Remote does not pair to the TV automatically, point it at the remote control sensor of the TV, and then press and hold the buttons labelled  and  as shown in the figure on the left simultaneously for 3 seconds or more.

## Installing batteries into the Samsung Smart Remote

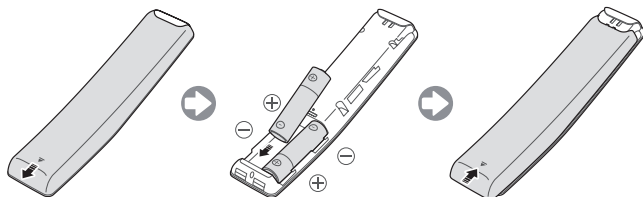

To install the batteries, push the rear cover open in the direction of the arrow, and then insert the batteries as shown in the figure. Make sure that the positive and negative ends are facing in the correct direction.

- Alkaline batteries are recommended for longer battery life.

# 06 Initial Setup

The initial setup dialogue box appears when the TV is first activated. Follow the on-screen instructions to finish the initial setup process. You can manually perform this process at a later time in the **Home** > **Settings** > **General** > **Start Setup** menu.

## Using the TV Controller

You can turn on the TV with the **TV Controller** button at the bottom of the TV, and then use the Control Menu. The **Control menu** appears when the TV Controller is pressed while the TV is On. For more information about its usage, refer to the figure below.

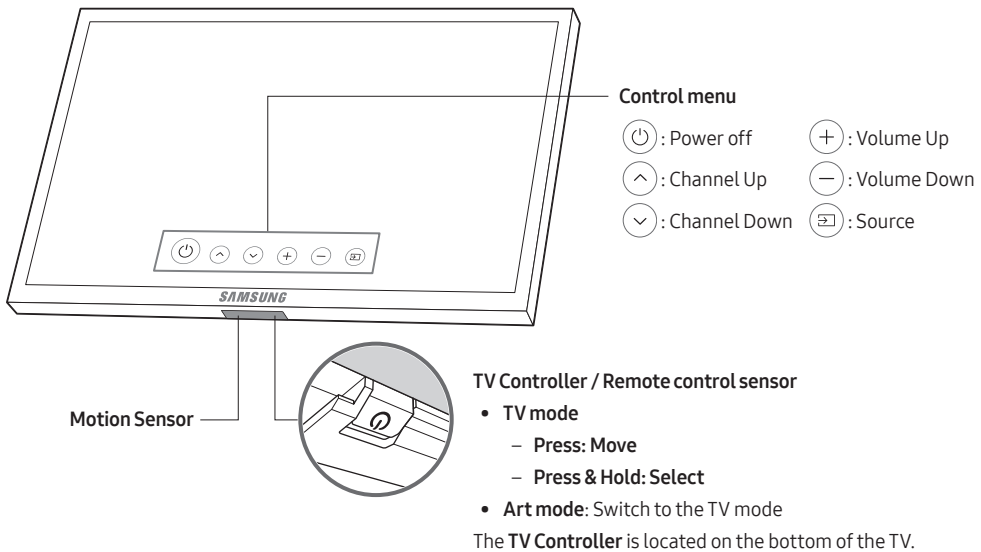

- When you press the **TV Controller** button, be careful not to press the motion sensor close to it.
- The remote control sensor LED remains on in the standby mode of TV mode and off in the standby mode of Art mode.
- After detaching the Customizable Frame (sold separately) from the TV, push up the remote control sensor so that it returns to its original position.
  - Do not push up the remote control sensor strongly. There is a risk of damage.

# 07 Connecting to a Network

Connecting the TV to a network gives you access to online services, such as Smart Hub, as well as software updates.

## Network Connection - Wireless

Connect the TV to the Internet using a standard router or modem.

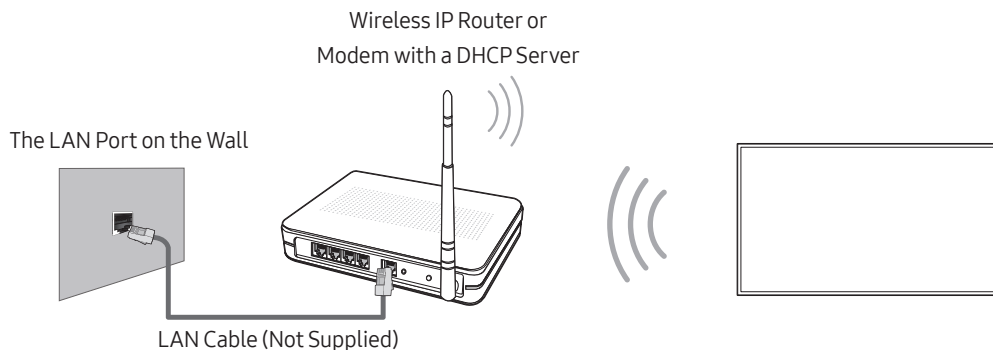

## Network Connection - Wired

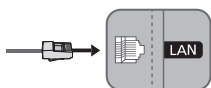

Connect your TV to your network using a LAN cable.

- The TV does not support the network speeds less than or equal to 10 Mbps.
- Use Cat7 (\*STP Type) cable for the connection.  
\* Shielded Twist Pair

## Mobile Network

Availability depends on the specific model and area.

While connecting to the mobile network, some functions might be unavailable.

Refer to the diagram and insert the Mobile Dongle (sold separately) into the USB port. The Mobile Dongle must be connected to the TV in order to connect to the mobile network. However, the Mobile Dongle is sold separately and is not available from Samsung.

If you have any problems using online services, please contact your Internet service provider.

- When you use a large mobile dongle(Data Card), USB devices may not work properly due to interferences among the USB ports, or the wireless network may not work properly due to interferences from the peripherals and surroundings. In this case, use a USB extension cable.

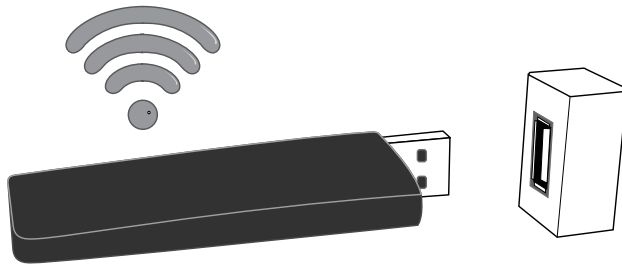

### Supported Telecom and Model Name

For more information, refer to the **e-Manual**.

# 08 Troubleshooting and Maintenance

## Troubleshooting

If the TV seems to have a problem, first review this list of possible problems and solutions. Alternatively, review the Troubleshooting Section in the e-Manual. If none of these troubleshooting tips apply, please visit “www.samsung.com” and click on Support, or contact the call centre listed on the back cover of this manual.

- This TFT LED panel is made up of sub pixels which require sophisticated technology to produce. There may be, however, a few bright or dark pixels on the screen. These pixels will have no impact on the performance of the product.
- To keep your TV in optimum condition, upgrade to the latest software. Use the **Update Now** or **Auto update** functions on the TV's menu (🏠 > ⚙️ **Settings** > **Support** > **Software Update** > **Update Now** or **Auto update**).

### The TV won't turn on.

- Make sure that the AC power cord is securely plugged in to the TV and the wall outlet.
- Make sure that the wall outlet is working and the power indicator on the TV is lit and glowing a solid red.
- Try pressing the Power button on the TV to make sure that the problem is not with the remote control. If the TV turns on, refer to “Remote control does not work” below.

### There is no picture/video/sound, or a distorted picture/video/sound from an external device, or “Weak or No Signal” is displayed on the TV, or you cannot find a channel.

- Make sure the connection to the device is correct and that all cables are fully inserted.
- Remove and reconnect all cables connected to the TV and the external devices. Try new cables if possible.
- Confirm that the correct input source has been selected (🏠 > **Source**).
- Perform a TV self diagnosis to determine if the problem is caused by the TV or the device (🏠 > ⚙️ **Settings** > **Support** > **Self Diagnosis** > **Start Picture Test** or **Start Sound Test**).
- If the test results are normal, reboot the connected devices by unplugging each device's power cord and then plugging it in again. If the issue persists, refer to the connection guide in the user manual of the connected device.
- If the TV is not connected to a cable or satellite box, run **Auto Tuning** to search for channels (🏠 > ⚙️ **Settings** > **Broadcasting** > **Auto Tuning**).
  - This function is only available on certain models in specific geographical areas.

## The remote control does not work.

- Check if the power indicator on the TV blinks when you press the remote's Power button. If it does not, replace the remote control's batteries.
- Make sure that the batteries are installed with their poles (+/-) in the correct direction.
- Try pointing the remote directly at the TV from 1.5 ~ 1.8 m away.
- If your TV came with a Samsung Smart Remote (Bluetooth Remote), make sure to pair the remote to the TV.

## The cable or satellite box remote control doesn't turn the TV on or off or adjust the volume.

- Programme the cable or satellite box remote control to operate the TV. Refer to the cable or satellite box user manual for the SAMSUNG TV code.

## The TV settings are lost after 5 minutes.

- The TV is in the **Retail Mode**. Change the **Usage Mode** in the **General** Menu to **Home Mode** (🏠 > ⚙️ **Settings** > **General** > **System Manager** > **Usage Mode** > **Home Mode**).



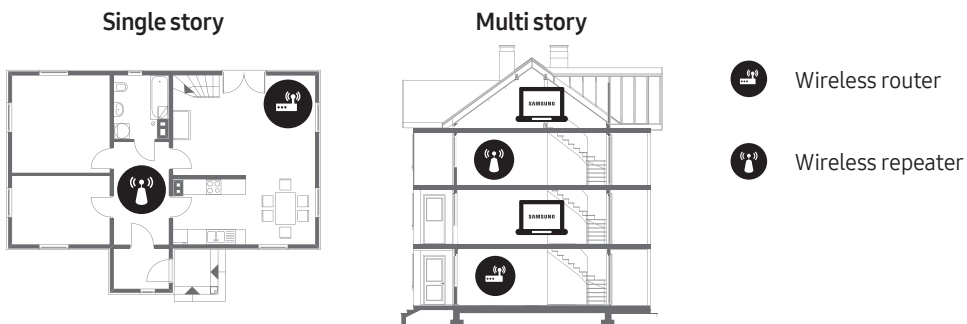

## Intermittent Wi-Fi

- Make sure the TV has a network connection (🏠 > ⚙️ **Settings** > **General** > **Network** > **Network Status**).
- Make sure the Wi-Fi password is entered correctly.
- Check the distance between the TV and the Modem/Router. The distance should not exceed 15.2 m.
- Reduce interference by not using or turning off wireless devices. Also, verify that there are no obstacles between the TV and the Modem/Router. (The Wi-Fi strength can be decreased by appliances, cordless phones, stone walls/fireplaces, etc.)



- Contact your ISP and ask them to reset your network circuit to re-register the Mac addresses of your new Modem/Router and the TV.

## Video App problems (Youtube etc)

- Change the DNS to 8.8.8.8. Select  >  **Settings** > **General** > **Network** > **Network Status** > **IP Settings** > **DNS setting** > **Enter manually** > **DNS Server** > enter 8.8.8.8 > **OK**.
- Reset by selecting  >  **Settings** > **Support** > **Self Diagnosis** > **Reset Smart Hub**.

## The TV remains on or does not turn on automatically.

- If the surrounding area is too dark or bright, the motion sensor may not work normally. The performance of the motion sensor may be affected by the installation environment (height, tilt, obstacles). If the clothes you wear or your skin colour is similar to the surrounding shading, the motion sensor may not work properly.
- The TV responds to all visual changes around it (lights, displays, dogs, out-of-window changes, and other occurrences). You can adjust the response level by adjusting the detection sensitivity.

## **Precautions when using Art mode**

- Do not block the sensor at the front of the TV. The motion sensor as well as the brightness and colour tone of the screen can be affected.
- Art mode uses algorithms to minimise image burn-in that can be caused by displaying still images on the screen for long periods of time. For TV mode still image precautions, see the "Still image warning."
- The performance of the sensor may vary depending on the TV installation and operating environment.
  - The screen brightness and colour may be affected depending on the colour of the bottom of the TV.
  - In an environment where special light sources other than standard light sources (halogen, fluorescent) are used, the sensor's motion recognition performance may vary. depending on the positions, types, and number of the light sources.
  - If the area around the TV is too dark or bright, the screen brightness may be limited or the sensor may not work normally.
  - If the TV is installed too high or too low, the sensor may not work normally.
  - The motion sensor may sense motion from a flashing LED, a pet, a car moving outside the window, or other occurrence and start operating.
- Depending on the **Auto Power Off** function settings, the TV may turn off when there is no user input in Art mode, such as inputs from the remote control.
- The **Sleep Timer** / **Off Timer** function does not work in Art mode.

## What is Remote Support?

Samsung Remote Support service offers you one-on-one support with a Samsung Technician who can remotely:

- Diagnose your TV
- Adjust the TV settings for you
- Perform a factory reset on your TV
- Install recommended firmware updates

## How does Remote Support work?

You can easily have a Samsung Tech service your TV remotely:

1. Call the Samsung Contact Centre and ask for remote support.
2. Open the menu on your TV and go to the **Support** section.
3. Select **Remote Management**, then read and agree to the service agreements. When the PIN screen appears, provide the PIN number to the agent.
4. The agent will then access your TV.

## Eco Sensor and screen brightness

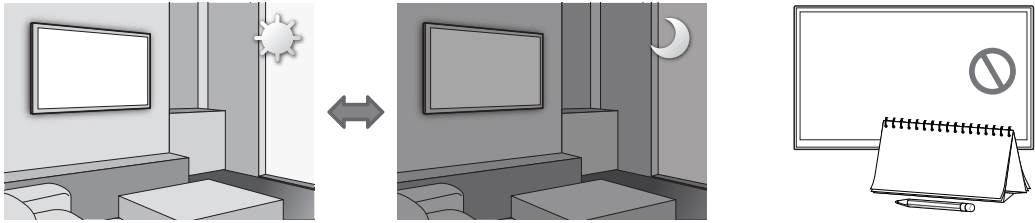

Eco Sensor adjusts the brightness of the TV automatically. This feature measures the light in your room and optimises the brightness of the TV automatically to reduce power consumption. If you want to turn this off, go to 

>  **Settings** > **General** > **Eco Solution** > **Ambient Light Detection**.

- If the screen is too dark while you are watching TV in a dark environment, it may be due to the **Ambient Light Detection** function.
- Do not block the sensor with any object. This can decrease picture brightness.



## Still image warning

When The Frame is in TV mode, avoid displaying still images (such as jpeg picture files), still image elements (such as TV channel logos, stock or news crawls at the screen bottom etc.), or programmes in panorama or 4:3 image format on the screen. If you constantly display still pictures, it can cause image burn-in on the LED screen and affect image quality. To reduce the risk of this adverse effect, please follow the recommendations below:

- Avoid displaying the same TV channel for long periods.
- Always try to display any image in full screen. Use the picture format menu of the TV for the best possible match.
- Reduce brightness and contrast to avoid the appearance of after-images.
- Use all TV features designed to reduce image retention and screen burn. Refer to the e-Manual for details.

## Caring for the TV

- If a sticker was attached to the TV screen, some debris can remain after you remove the sticker. Please clean the debris off before watching TV.
- The exterior and screen of the TV can get scratched during cleaning. Be sure to wipe the exterior and screen carefully using a soft cloth to prevent scratches.
- Do not spray water or any liquid directly onto the TV. Any liquid that goes into the product may cause a failure, fire, or electric shock.
- To clean the screen, turn off the TV, then gently wipe away smudges and fingerprints on the panel with a micro-fiber cloth. Clean the body or panel of the TV with a micro-fiber cloth dampened with a small amount of water. After that, remove the moisture with a dry cloth. While cleaning, do not apply strong force to the surface of the panel because it can damage the panel. Never use flammable liquids (benzene, thinner, etc.) or a cleaning agent. For stubborn smudges, spray a small amount of screen cleaner on a micro-fiber cloth, and then use the cloth to wipe away the smudges.

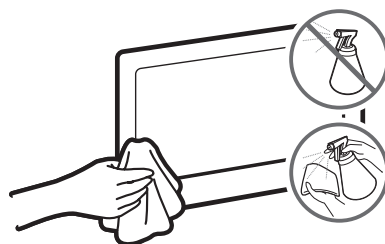

# 09 Specifications and Other Information

## Specifications

<b>Model Name</b>	UA55LS003	UA65LS003
<b>Display Resolution</b>	3840 x 2160	3840 x 2160
<b>Screen Size (Diagonal)</b>	138 cm	163 cm
<b>Sound (Output)</b>	40 W	40 W
<b>Stand Swivel (Left / Right)</b>	0°	0°
<b>Dimensions (W x H x D)</b>		
<b>Body</b>	123.50 x 70.78 x 4.25 cm	145.39 x 83.09 x 4.25 cm
<b>With stand</b>	123.50 x 75.07 x 20.00 cm	145.39 x 87.55 x 29.40 cm
<b>Weight</b>		
<b>Without Stand</b>	18.6 kg	25.4 kg
<b>With Stand</b>	19.1 kg	26.2 kg

## Environmental Considerations

<b>Operating Temperature</b>	50°F to 104°F (10°C to 40°C)
<b>Operating Humidity</b>	10% to 80%, non-condensing
<b>Storage Temperature</b>	-4°F to 113°F (-20°C to 45°C)
<b>Storage Humidity</b>	5% to 95%, non-condensing

- The design and specifications are subject to change without prior notice.
- For information about the power supply, and more information about power consumption, refer to the label-rating attached to the product.
- You can see the label-rating inside of the cover terminal.

## Decreasing power consumption

When you shut the TV off, it enters Standby mode. In Standby mode, it continues to draw a small amount of power. To decrease power consumption, unplug the power cord when you don't intend to use the TV for a long time.

## Licences



The terms HDMI and HDMI High-Definition Multimedia Interface, and the HDMI Logo are trademarks or registered trademarks of HDMI Licensing LLC in the United States and other countries.

### For India only

This product is RoHS compliant.



This marking on the product, accessories or literature indicates that the product and its electronic accessories should not be disposed of with other household waste at the end of their working life.

To prevent possible harm to the environment or human health from uncontrolled waste disposal, please separate these items from other types of waste and recycle them responsibly to promote the sustainable reuse of material resources.

For more information on safe disposal and recycling visit our website [www.samsung.com/in](http://www.samsung.com/in) or contact our Helpline numbers-1800 40 SAMSUNG(1800 40 7267864) (Toll-Free)

WARNING - TO PREVENT THE SPREAD OF FIRE, KEEP CANDLES OR OTHER ITEMS WITH OPEN FLAMES AWAY FROM THIS PRODUCT AT ALL TIMES.



# SAMSUNG

## Contact SAMSUNG WORLD WIDE

If you have any questions or comments relating to Samsung products, please contact the SAMSUNG customer care centre.

Country	Customer Care Centre ☎	Web Site
SINGAPORE	1800-SAMSUNG(726-7864)	<a href="http://www.samsung.com/sg/support">www.samsung.com/sg/support</a>
AUSTRALIA	1300 362 603	<a href="http://www.samsung.com/au/support">www.samsung.com/au/support</a>
NEW ZEALAND	0800 726 786	<a href="http://www.samsung.com/nz/support">www.samsung.com/nz/support</a>
VIETNAM	1800 588 889	<a href="http://www.samsung.com/vn/support">www.samsung.com/vn/support</a>
THAILAND	0-2689-3232 1800-29-3232 (Toll free)	<a href="http://www.samsung.com/th/support">www.samsung.com/th/support</a>
MYANMAR	+95-1-2399-888	<a href="http://www.samsung.com/th/support">www.samsung.com/th/support</a>
CAMBODIA	+855-23-993232 1800-20-3232 (Toll free)	
LAOS	+856-214-17333	
MALAYSIA	1800-88-9999 +603-7713 7420 (Overseas contact)	
INDONESIA	021-5699-7777 0800-112-8888 (All Product, Toll Free)	<a href="http://www.samsung.com/id/support">www.samsung.com/id/support</a>
PHILIPPINES	1-800-10-726-7864 [ PLDT Toll Free ] 1-800-8-726-7864 [ Globe Landline and Mobile ] 02- 422-2111 [ Standard Landline ]	<a href="http://www.samsung.com/ph/support">www.samsung.com/ph/support</a>
TAIWAN	0800-329-999 (All Product)	<a href="http://www.samsung.com/tw/support">www.samsung.com/tw/support</a>
JAPAN	0120-363-905	<a href="http://www.galaxymobile.jp/jp/support">www.galaxymobile.jp/jp/support</a>
INDIA	1800 40 SAMSUNG (1800 40 7267864) (Toll-Free)	<a href="http://www.samsung.com/in/support">www.samsung.com/in/support</a>
NEPAL	16600172667 (Toll Free for NTC Only) 9801572667	<a href="http://www.samsung.com/in/support">www.samsung.com/in/support</a>
BANGLADESH	09612300300 08000300300 (Toll free)	<a href="http://www.samsung.com/in/support">www.samsung.com/in/support</a>
SRI LANKA	+9411SAMSUNG (+94117267864) +94117540540 +94115900000	<a href="http://www.samsung.com/in/support">www.samsung.com/in/support</a>
EGYPT	08000-7267864 16580	<a href="http://www.samsung.com/eg/support">www.samsung.com/eg/support</a>
ALGERIA	3004	<a href="http://www.samsung.com/n_africa/support">www.samsung.com/n_africa/support</a>
IRAN	021-8255 [CE]	<a href="http://www.samsung.com/iran/support">www.samsung.com/iran/support</a>
ISRAEL	*6963	<a href="http://www.samsung.com/il/support">www.samsung.com/il/support</a>
SAUDI ARABIA	(+966) 8002474357 (800 24/7 HELP)	<a href="http://www.samsung.com/sa/home">www.samsung.com/sa/home</a> <a href="http://www.samsung.com/sa_en">www.samsung.com/sa_en</a>
PAKISTAN	0800-Samsung (72678)	<a href="http://www.samsung.com/pk/support">www.samsung.com/pk/support</a>
TUNISIA	80 100 012	<a href="http://www.samsung.com/n_africa/support">www.samsung.com/n_africa/support</a>
U.A.E	800-SAMSUNG (800 - 726 7864)	<a href="http://www.samsung.com/ae/support">www.samsung.com/ae/support</a> (English) <a href="http://www.samsung.com/ae_ar/support">www.samsung.com/ae_ar/support</a> (Arabic)
OMAN	800-SAM CS (800-72627)	
KUWAIT	183-CALL (183-2255)	
BAHRAIN	8000-GSAM (8000-4726)	
QATAR	800-CALL (800-2255)	<a href="http://www.samsung.com/tr/support">www.samsung.com/tr/support</a>
TURKEY	444 77 11	
JORDAN	0800-22273 06 5777444	
SYRIA	962 5777444	
LEBANON	1299	<a href="http://www.samsung.com/levant/support">www.samsung.com/levant/support</a>
IRAQ	80010080	
MOROCCO	080 100 22 55	

